



POSIWIRE® Position Sensors

Installation and operation manual



Please read carefully before operation!

Contents	Safety instructions	3
	Intended use / unintended use	5
	Product description	
	Operating principle	6
	Measurement signal and range	6
	Delivery / shipment	7
	Mating connectors	7
	Installation	
	Precautions	8
	Female connector 90° CONN-DIN-8F-W	13
	Female connector CONN-M12-8F-G	14
	Female connector CONN-CONIN-12F-G	15
	Connection	16
	Cable dust wiper SAB5	17
	Calibration	18
	Electromagnetic compatibility (EMC)	18
	Repair and disposal	18
	<u>Appendix</u>	
	Output specifications	19
	Analog Output	19
	with Potentiometer	19
	with Magnetic Absolute Encoder	23
	Incremental Output	25
	with Optical Incremental Encoder	25
	SSI Interface	28
	with Potentiometer	28
	with Magnetic Absolute Encoder	29
	with Optical Absolute Encoder	30
	CAN-Bus	32
	with Potentiometer	32
	with Magnetic Absolute Encoder	33
	with Optical Absolute Encoder	48
	DeviceNet	49
	Profibus DP	50
	Interbus	51
	Output Information	52
	Reliability Characteristics	56
	Declaration of Conformity	57

**Safety
instructions**

If total failure or malfunction of the sensor can cause danger or injury to the operator or damage to the machinery or equipment it is recommended that additional safety measures should be incorporated into the system.

Any alteration, reconstruction or extension of the sensor is not allowed.

Sensor must be operated only within values specified in the datasheet.



Connection to power supply must be performed in accordance with safety instructions for electrical facilities and performed only by trained staff.

Disregard of this advice can lead to malfunctions, damage to property or personal injury and releases the manufacturer from product liability.

Crossing the dew point must be avoided.

Explanation of used
safety signs and
signal words



WARNING, Risk of Injury:

Indicates a potentially hazardous situation, which, if not avoided, could result in serious injury or property damage.

DANGER

WARNING, Risk of Personal Injury or Death:

Indicates a situation that can result in serious personal injury or death if not properly avoided.

WARNING

WARNING, Risk of Personal Injury or Death:

Indicates a situation that can result in moderate personal injury or death if not properly avoided.

CAUTION

WARNING, Risk of Personal Injury:

Indicates a situation that can result in minor personal injury if not properly avoided.

NOTICE

WARNING, Risk of Property Damage:

Indicates a situation that can result in minor to major property damage if not properly avoided.

**Safety
instructions**
(continued)

Do not open sensor

- Release of spring under tension can result in injury!

Do not snap cable

- Uncontrolled cable retraction can break off cable fixing (cable clip or M4 connection). Broken fixing and cable can result in injury. Also sensor will be damaged!

Do not travel over range

- Uncontrolled cable retraction can result in injury. Also sensor will be damaged!

Special attention during mounting and operation of metal cable sensors

- Risk of injury by the measuring cable!

Sensors without cover / housing (OEM sensors)

- Risk of injury by moving parts. Mounting and operation of the sensor only with appropriate safety equipment that an injury is impossible!

Do not exceed maximum operating voltage listed in the catalog

- Risk of injury. Sensor will be damaged!

Avoid shock and vibration to the sensor

- Sensor will be damaged!

Intended use

The position sensor was intended for linear position measurement, when properly mounted and used in the properly rated ambient atmospheric and technical conditions for which the sensor is designated.

Unintended use

The unintended use is when the sensor is used outside its specified technical and ambient atmospheric conditions or when improperly mounted.

Product description

The purpose of position sensors is to transform position of a linear and guided movement into an electrical signal. Specifications of measuring range, environment, handling and connections as specified in the catalog, must be followed.

The catalog is part of this instruction manual. If the catalog is not available it may be requested by stating the respective model number.

The Operating Principle

Linear motion of the measuring cable (flexible stainless steel) is converted into rotation by means of a precision cable drum. A spring motor provides torque for the cable retraction. Special design assures precise and reproducible winding of the measuring cable.

Cable extraction or retraction is transformed into an electrical signal. Depending on application different sensing elements are used.

Optional: Subsequent signal conditioners convert the signal of the sensing element into voltage, current, or digital pulses suitable for standard interfaces.

Measurement Signal and Range

Measurement signal:

Analog, not adjusted
 Potentiometer
 Sensitivity not adjustable

Resistance range is used from about 3% to 98%. 0% or 100% are not possible. Individual sensitivity is specified on the label.

Analog, adjusted
 Integrated signal conditioner
 Sensitivity adjusted

Measuring range corresponds to the electrical measuring range (e.g. 4...20 mA).

Digital incremental
 Incremental encoder
 Sensitivity not adjustable

Individual sensitivity is specified on label in pulses or increments per millimeter.

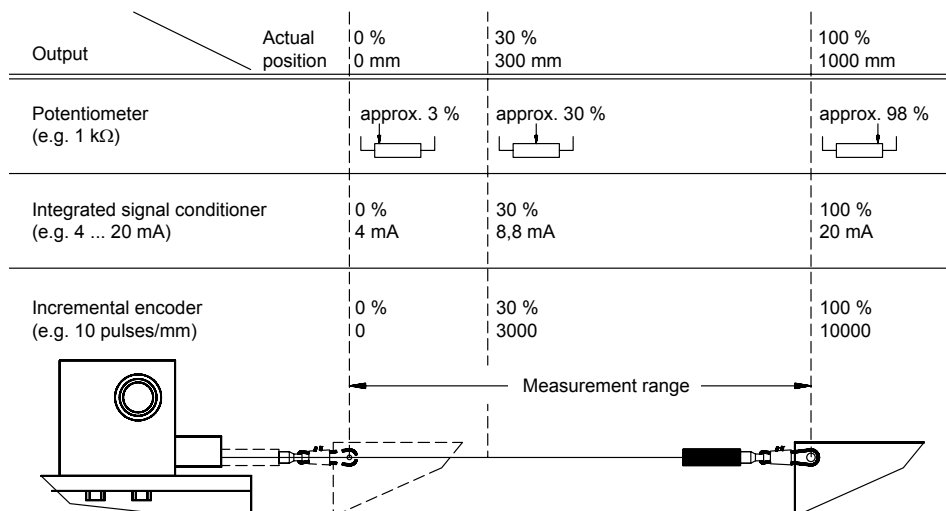

**Delivery /
shipment**

Unpacking

Do not unpack sensor by pulling cable or cable clip.

Shipment damages

Check sensor immediately for shipping damage.

Shipment protection loop
(not to be confused with the
mounting loop below!)

Do not remove until mounting.
(prevents cable movement before
mounting)

In case of any damage or equipment not operating appropriately, please contact supplier or ASM GmbH Moosinning. To avoid shipment damages, use original protection facilities and original packing for further shipment.

Mating connectors

Delivery does not include female connectors for electrical connection. They are available under the following order code:

90° female 8-pin connector DIN

CONN-DIN-8F-W

Female 8-pin connector M12

CONN-M12-8F-G

90° female 12-pin connector DIN

CONN-DIN-12F-W

Female 12-pin connector

CONN-CONIN-12F-G

Installation



- Do not damage cable!
- Cable must not be oiled or lubricated!
- Do not snap cable!
- Do not travel over range!
- Do not crack cable!
- Cable travel should be axial to the cable outlet
 - no misalignment allowed!
- Do not drag cable along objects!

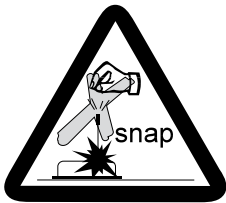

Precautions

Do not let snap the cable

Uncontrolled retraction of cable may damage sensor.
No warranty will be granted for snapped cables.

Mounting hints for unfavourable conditions

If possible fasten cable fixing with cable in retracted position.
For example, fit a mounting loop (see diagram) and put it around your wrist.
Do not remove the mounting loop before the cable is fastened.
The cable clip may be opened for easy attachment.

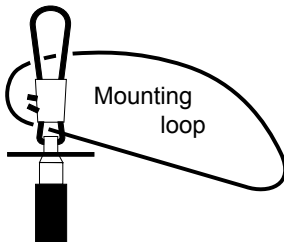

Mounting

To ensure proper operation, install the sensor only as described in this manual.

Installation (continued)

Installation position

Covered or shielded travel of cable is preferred. This prevents cable from damage, soiling and manipulation.

Cable outlet is preferred pointing downwards. Soaking of liquids into the cable outlet is impossible, concentration of condensing water will be avoided.

Fit sensor on plain base or use three-point mounting on uneven surfaces. This prevents sensor from bending and damage.

Cable travel should only be axial to the cable outlet - no misalignment is allowed.

Cable misalignment shortens service life of sensor and causes error in measurement. Warranty will not be granted for damage caused by misalignment.

If cable travel axial to the cable outlet is not possible, the cable guide wheel SR2 (accessories) must be used in order to turn the cable.

For special applications extension cables with clips on both ends are available.

Fitting the sensor

Depending upon the sensor model, holes in the base plate, threads or T-slots in the sensor housing enable attachment of the sensor. Dimensions required are listed in the catalog.

Cable attachment device

For fastening the cable clip the following solutions are available. For example:

- | | |
|--|---|
| a) Set screw M5:
(Allen screw) | Standard fixing. |
| b) Attachment head GK1/GK2:
(accessory) | Fast cable attachment, easy to remove. |
| c) Magnetic clamp MAG1:
(accessory) | An easy way to fasten the cable to ferromagnetic materials. |

The mounting of the M4 connection is made with a through hole and a M4 nut. Note: Do not screw the M4 connection itself into a stationary object, otherwise the measuring cable will be twisted!

Cable clip attachment

When fastening the cable clip take notice of the chapter *Installation / Precautions* (page 6).

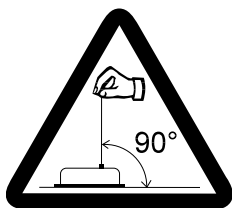

Installation
 (continued)

Model	Sensor fastening			
	Holes in the base plate	Threads in the sensor housing	Clamping claws	Mounting brackets
WS10xx	-	X	-	-
WS12xx	-	X	-	-
WS17xx	X	-	-	-
WS19KT	X	-	-	-
WS58C	-	X	-	-
WS7.5x	X	-	-	-
WS60	X	-	-	-
WS100M	X	-	-	-
WS31x	-	X	X	X
WS42x	-	X	X	X

Torque

- The following torques / screws and screw materials are recommended.
- Use flat washers and/or screw protection if necessary.
- The user is responsible for the appropriate torque, since ASM does not know the operational conditions of the application.

Model	Screw	Material	Torque [Nm]
WS10xx	M5	A2	4,5
WS12xx	M5	A2	4,5
WS58C	M4	A2	1,3
WS31x	M2,5	A2	0,45
WS42x	M2,5	A2	0,45

Installation
(continued)

Sensors with holes in the base plate



Mount the sensor on the flat surface.

Fixing is possible laterally or on the bottom side of the sensor.

For the length of thread engagement see the outline drawing in the data sheet.

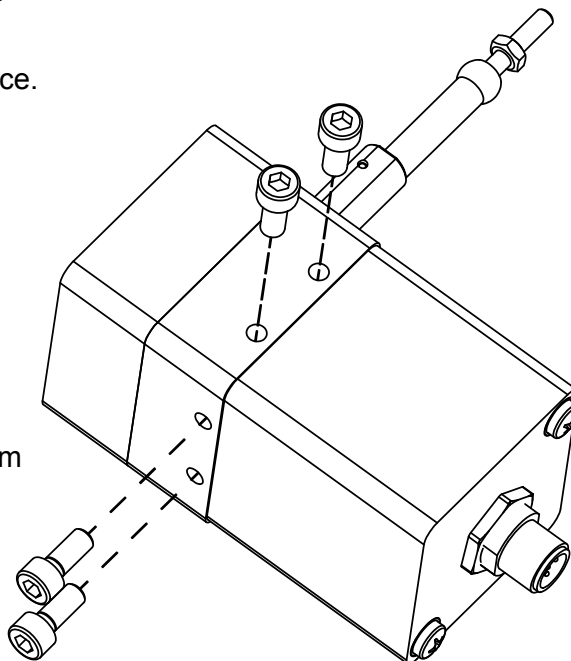

Example: WS10xx

Fixing with clamping claws



Mount the clamping claws on the flat surface.

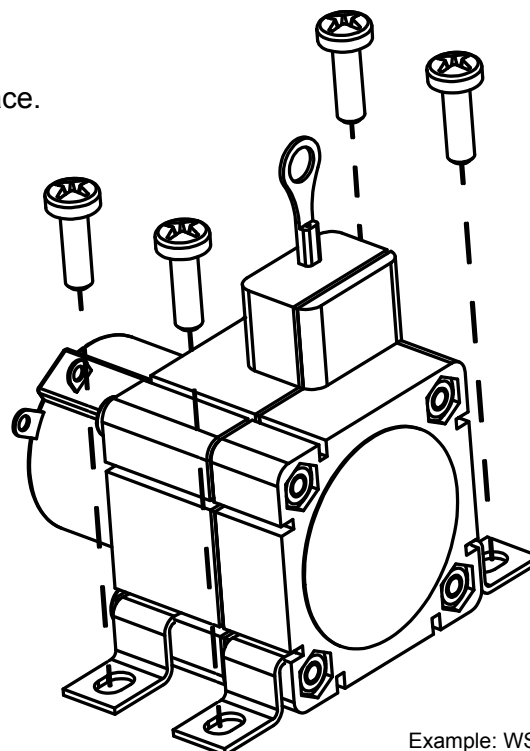

Example: WS31x

Installation
(continued)

Fixing with mounting brackets

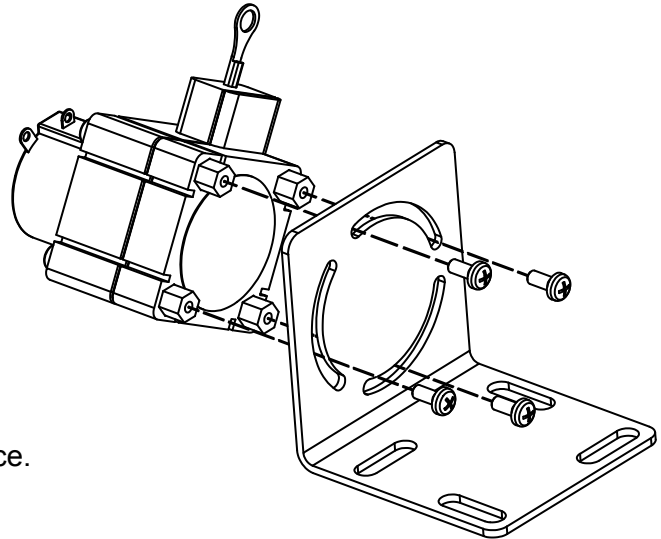

Mount the brackets on the flat surface.

Example: WS31x

Sensors with holes in the base plate



Mount the sensor on the flat surface.

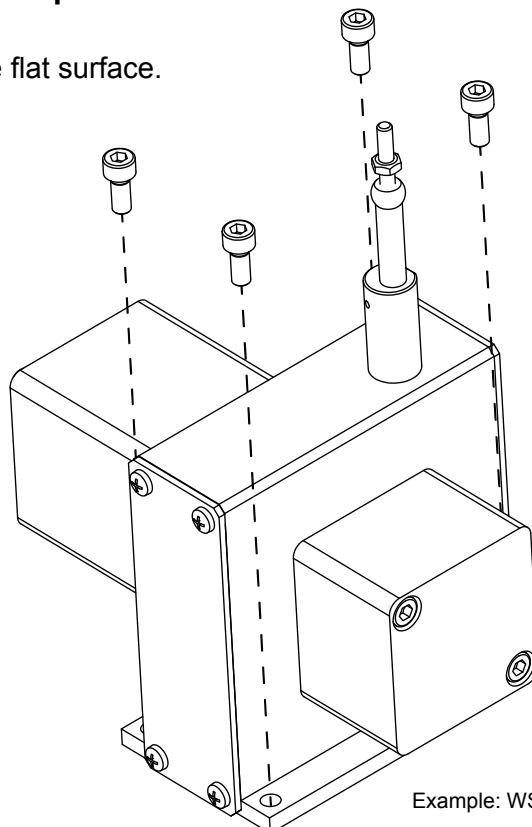

Example: WS17xx

Installation
 (continued)

90° female connector CONN-DIN-8F-W

<u>Part no.:</u>	<u>Operation:</u>
1 to 2	Assemble O-rings (lubricate!) on shielding ring and rotating hull.
3 to 7	Stringing parts and cut off projecting braiding. Note detail drawing of shielding! (See chapter <i>Electromagnetic Compatibility / EMC</i>).
8	Thread wires through housing, then assemble shielding ring, sealing ring and pinch ring. Turn on pressing screw to fix the cable, solder wires.
9 to 13	Assemble remaining parts according to diagram, fasten pressing screw.
14	Insert profile seal and fix female connector at male socket.

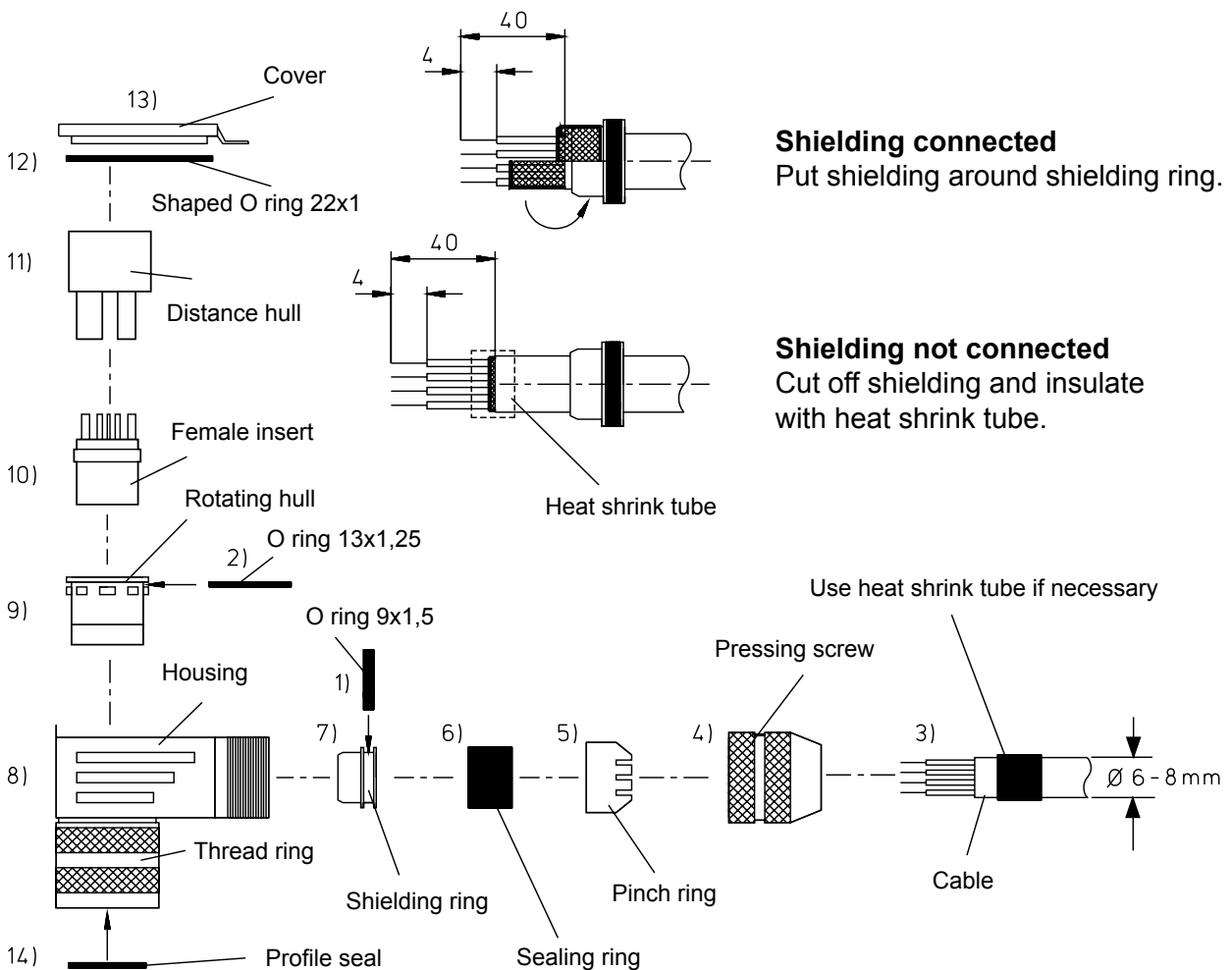

Installation
(continued)



The sensor protection class (IP) is only valid when the electrical plug is correctly connected.

To ensure sensor protection class assemble all connector seals carefully. The connector is suitable for cable diameters of 6 to 8 mm.

The sealing ring has to enclose the cable tightly (use heat shrink tube if necessary).

Note: Four different directions of the angled outlet are possible (4 x 90°) by changing the position of the rotating hull (part no. 9 in the drawing previous page).

Female connector CONN-M12-8F-G

1. Stringing parts.
2. Dismantle, expand shield and turn over the shielding ring.
3. Push isolating hull into the housing. Thread wires through housing, the assemble shielding ring, sealing ring and pinch ring. Turn on pressing screw to fix the cable. Screw wires.
4. Screw insert into housing and fasten pressing screw.

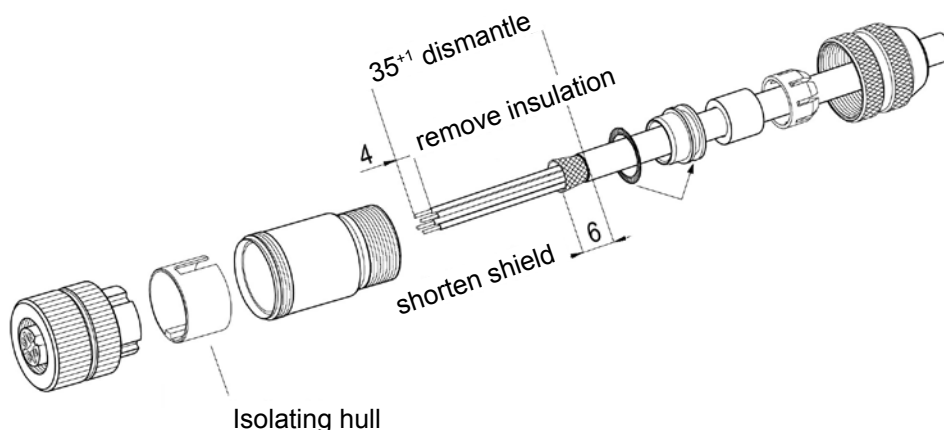

The sensor protection class (IP) is only valid when the electrical plug is correctly connected.

To ensure sensor protection class assemble all connector seals carefully. The connector is suitable for cable diameters of 6 to 8 mm.

The sealing ring has to enclose the cable tightly (use heat shrink tube if necessary).

Installation
(continued)

Female connector CONN-CONIN-12F-G

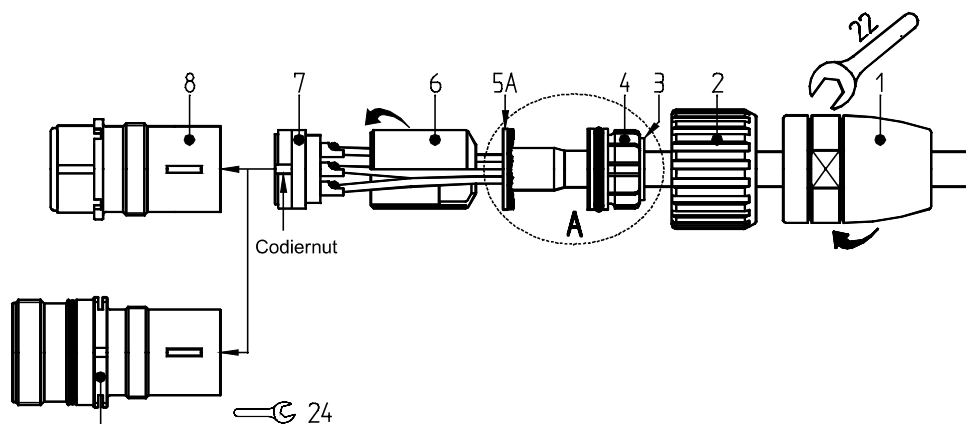

1. Slide the adaptor pos. 1, the sleeve nut pos. 2, the sealing element pos. 4 with sealing ring pos. 3 onto the cable.
2. Dismantle the outer sheath of the cable at a length of 23 mm.
3. Turn the shielding braid 90° up, move the shielding ring pos. 5A with a little rotation over the plastic film resp. the cotton mesh but under the shielding braid; cut off the shielding braid flushing with the outer diameter of the shielding ring pos. 5A.
4. Cut off plastic film, filler and inner isolation.
5. Strip the wires a length of 3,5 mm, twist (and tin).
6. Solder, crimp or screw the wires to the contacts.
7. Insert distance hull pos. 6.
8. Move insert pos. 7 and distance hull pos. 6 into the insert hull pos. 8; please see to it that the desired code notch of the insert pos. 7 is inserted correctly into the code bar.
9. Push in the cable with shielding and sealing unit.
10. Screw the adaptor pos. 1 tight!



The sensor protection class (IP) is only valid when the electrical plug is correctly connected.
To ensure sensor protection class assemble all connector seals carefully.
The connector is suitable for cable diameters of 6 to 8 mm.
The sealing ring has to enclose the cable tightly (use heat shrink tube if necessary).

Connection	Signal wiring	See <i>Output specifications</i> (appendix).
	Operating voltage	According to <i>Output specifications</i> (appendix). Do not exceed the listed maximum operating voltage.
	Special encoders	Instruction manuals of special encoders have to be noticed.

For connection of outputs not listed in the connection table see data sheets or special connection diagrams.

Connection example: current output 420A

To convert the 4 ... 20 mA signal into a voltage signal, it needs a load resistor R_M (measuring resistor) as shown in the diagram. The maximum value of R_M depends on the cable resistance R_L and the excitation voltage U_B :

$$R_{Mmax} = ((U_B - 12 V)/0,02 A) - R_L$$

With an excitation of 24 V DC and a cable resistance $R_L = 500 \Omega$ a maximum value of $R_M = 100 \Omega$ can be used.

External circuit

Voltage drop at the precision resistor

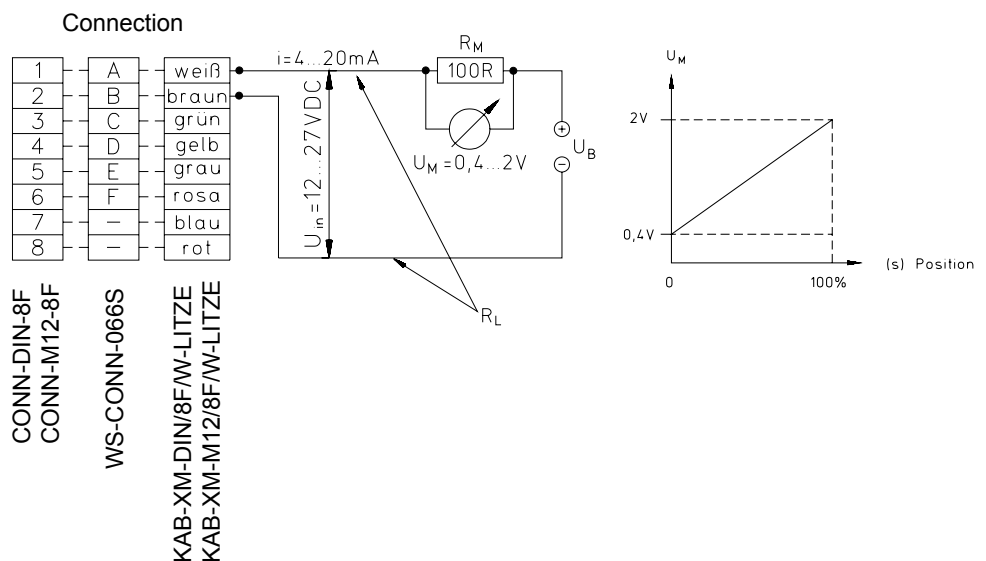

**Cable dust wiper
SAB5**

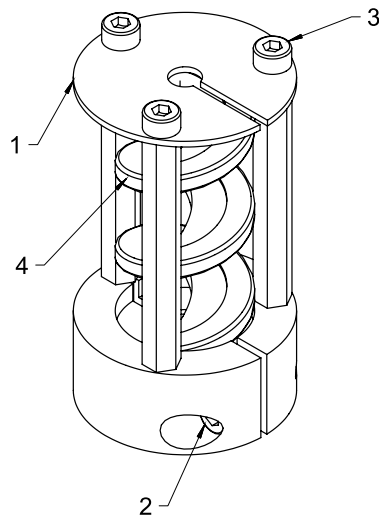

1. Disassemble the aluminium washer (1) by removing the three M3 screws (3).
2. Remove the spiral wiper (4).
3. Fix the basic body at the cable outlet of the sensor by the set screw M3 (2). See to it that the sensor measurement cable is in centric position.
4. Thread the measurement cable into the spiral wiper.
Do not bend the measurement cable!
Don't let snap back the cable!
5. Assemble the aluminium washer.

Calibration

The recommended calibration interval is 1 year.

Test protocol and traceable calibration certificate (ISO9001 / ISO10012) is available on request.

Electromagnetic Compatibility (EMC)

The electromagnetic compatibility depends on wiring practice. Recommended wiring:

- Use shielded twisted pair sensor cable.
- Ground shield single ended at switch cabinet. Connect shield directly before or at cable inlet of switch cabinet by low impedance ground cable bond. On delivery of preassembled sensor cables the shield is not connected to the sensor housing.
- Keep sensor signal well separated from power wiring e.g. AC wiring, motor or relay. Use separate conduit or ducts for each.

If application includes highly electromagnetic interference emitting equipment like switch converter drives additional measures are recommended:

- Use a twisted pair cable, shielded per pair and common.
- Use shielded conduits or ducts connected to ground potential.

Repair and Disposal



DANGER

Sensors and accessories have to be repaired and adjusted at ASM in Moosinning.

In order to avoid risk of injury and improper handling do not try to repair. No warranty or liability will be granted for opened sensors.

Send metal parts for recycling!

Disposal according to applicable government regulations.

POSIWIRE®
with Potentiometer
Voltage divider



Voltage divider R1K
Potentiometer

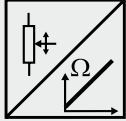

The Potentiometer must be connected as a voltage divider!
The following processing circuit has to be implemented
according to the circuit scheme in the Appendix
(see „Appendix – Output Information“)!

Excitation voltage	32 V DC max. at 1 kΩ (max. power 1 W)
Potentiometer impedance	1 kΩ ±10 %
Thermal coefficient	±25 x 10 ⁻⁶ / °C f.s.
Sensitivity	Depends on the measuring range, individual sensitivity of the sensor is specified on the label
Voltage divider utilization range	Approx. 3 % ... 97 %
Operating temperature	-20 ... +85 °C

Signal wiring potentiometer WS31/42	CT-Poti / 5 turn 250 / 500 mm		Multi turn-Poti / 10 turn 750 / 1000 mm	
	Poti +	M	Poti +	CCW
Poti GND	CW	Poti GND	CW	
Poti slider	S	Poti slider	S	

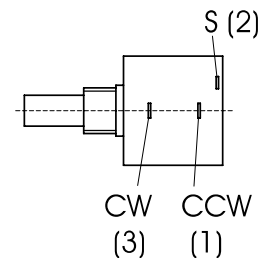
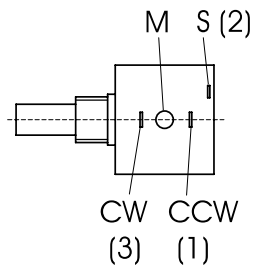

Signal wiring	Signal	Plug connection	Cable connection	Cable connection
			[WH, BN, GN, YE]	[BN, WH, BU, BK, GY]
	Potentiometer +	1	white	brown
	Potentiometer GND	2	brown	white
	Potentiometer slider	3	green	blue
	-	4	yellow	black
	-	5	-	grey
	-	6	-	-
	-	7	-	-
	-	8	-	-

Connection

View to soldering side
of mating connector

CONN-M12-8F
A codification

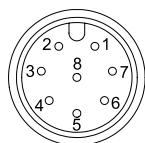

CONN-DIN-8F

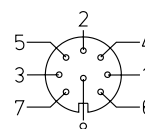

POSIWIRE®
with Potentiometer
Analog Output

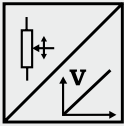

Signal conditioner 10V and 10V5 Voltage output 	Excitation voltage	18 ... 27 V DC non stabilized
	Excitation current	20 mA max.
	Output voltage	10V: 0 ... 10 V DC; 10V5: 0.5 ... 10 V DC
	Output current	2 mA max.
	Output load	> 5 kΩ
	Stability (temperature)	±50 x 10 ⁻⁶ / °C f.s.
	Protection	Reverse polarity, short circuit
	Output noise	0.5 mV _{RMS}
	Operating temperature	-20 ... +85 °C
	EMC	EN 61326-1:2013

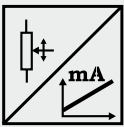
Signal conditioner 420T Current output (3 wire) 	Excitation voltage	18 ... 27 V DC non stabilized
	Excitation current	40 mA max.
	Load resistor	350 Ω max.
	Output current	4 ... 20 mA equivalent for 0 ... 100 % range
	Stability (temperature)	±50 x 10 ⁻⁶ / °C f.s.
	Protection	Reverse polarity, short circuit
	Output noise	0.5 mV _{RMS}
	Operating temperature	-20 ... +85 °C
	EMC	EN 61326-1:2013

Signal wiring	Signal	Plug connection	Cable connection
5-pin	Excitation +	1	brown
	Signal	2	white
	GND	3	blue
	Do not connect	4	black
	Do not connect	5	grey

Connection

View to soldering side of mating connector

CONN-M12-5F
A codification

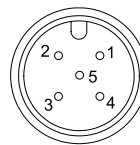

Signal wiring	10V / 10V5 / 420T	Plug connection	Cable connection
8-pin	Excitation +	1	white
	Excitation GND	2	brown
	Signal +	3	green
	Signal GND	4	yellow
	-	5,6,7,8	grey, pink, blue, red

Connection

View to soldering side of mating connector

- Check sensor type! -

CONN-M12-8F
A codification

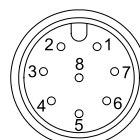

CONN-DIN-8F

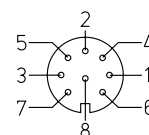

POSIWIRE®
with Potentiometer
Analog Output

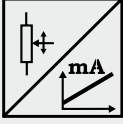

Signal conditioner 420A Current output (2 wire) 	Excitation voltage	12 ... 27 V DC non stabilized, measured at the sensor terminals
	Excitation current	35 mA max.
	Output current	4 ... 20 mA equivalent for 0 ... 100 % range
	Stability (temperature)	$\pm 100 \times 10^{-6} / ^\circ\text{C}$ f.s.
	Protection	Reversed polarity, short circuit
	Output noise	0.5 mV _{RMS}
	Operating temperature	-20 ... +85 °C
	EMC	EN 61326-1:2013

Signal wiring	Signal	Plug connection	Cable connection
	Signal +	1	white
	Signal -	2	brown
	-	3	green
	-	4	yellow
	-	5	grey
	-	6	pink
	-	7	blue
	-	8	red

Connection

View to soldering side of mating connector

- Check sensor type! -

CONN-M12-8F
A codification

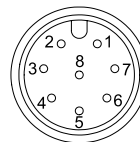

CONN-DIN-8F

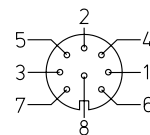

POSIWIRE®
with Potentiometer
Analog Output



Signal conditioner PMUV / PMUI Voltage or current output (3 wire)	Excitation voltage	18 ... 27 V DC
	Excitation current	50 mA max.
	Voltage output PMUV	0 ... 10 V
	Output current	10 mA max.
	Output load	1 kΩ min.
	Current output PMUI	4 ... 20 mA (3 wire)
	Working resistance	500 Ω max.
	Scaling	
	Activation of offset and gain adjust	Connect with excitation GND (0 V)
	Scalable range	90% max. f.s.
Stability (temperature)	±50 x 10 ⁻⁶ / °C f.s.	
Operating temperature	-20 ... +85 °C	
Protection	Reversed polarity, short circuit	
EMC	EN 61326-1:2013	

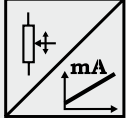
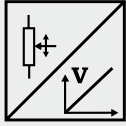

Signal wiring PMUV / PMUI	Signal	Plug Connection	Cable connection 8 wire	Cable connection 6 wire
	Excitation +	1	white	white
Excitation GND	2	brown	brown	
Signal +	3	green	green	
Signal GND	4	yellow	yellow	
Not used	5	grey	-	
Not used	6	pink	-	
Offset	7	blue	grey	
Gain	8	red	pink	

Signal wiring PMUI2	Signal	Plug connection	Cable connection
	Excitation +	1	white
Excitation GND	2	brown	
Not used	3	green	
Not used	4	yellow	
Signal +	5	grey	
Signal GND	6	pink	
ZERO	7	blue	
END	8	red	

Connection

View to soldering side
of mating connector

- Check sensor type! -

CONN-M12-8F
A codification

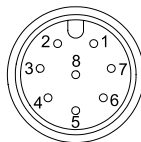

CONN-DIN-8F

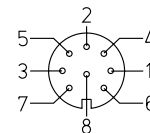

WSxxP / WS100M / POSIWIRE®
with Absolute Magnetic Encoder
Analog Output

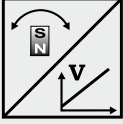
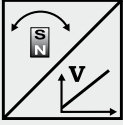
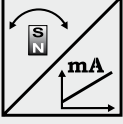

U2 Voltage output 0.5 ... 10 V 	Excitation voltage	10 ... 36 V DC
	Excitation current	typ. 20 mA at 24 V DC typ. 38 mA at 12 V DC max. 60 mA
	Output voltage	0,5 ... 10 V DC
	Output current	2 mA max.
	Measuring rate	1 kHz standard
	Stability (temperature)	$\pm 50 \times 10^{-6}/^{\circ}\text{C}$ f.s. (typical)
	Protection	Reverse polarity, short circuit
	Operating temperature	-20 ... +85° C
	EMC	EN61326-1:2013
	U8 Voltage output 0.5 ... 4.5 V 	Excitation voltage
Excitation current		typ. 17 mA at 24 V DC typ. 32mA at 12 V DC max. 60 mA
Output voltage		0,5 ... 4,5 V DC
Output current		2 mA max.
Measuring rate		1 kHz standard
Stability (temperature)		$\pm 50 \times 10^{-6}/^{\circ}\text{C}$ f.s. (typical)
Protection		Reverse polarity, short circuit
Operating temperature		-20 ... +85° C
EMC		EN61326-1:2013
I1 Current output 4 ... 20 mA, 3 wire 		Excitation voltage
	Excitation current	typ. 36 mA at 24 V DC typ. 70 mA at 12 V DC max. 100 mA
	Load R_L	500 Ω max.
	Output current	4 ... 20 mA
	Measuring rate	1 kHz standard
	Stability (temperature)	$\pm 50 \times 10^{-6}/^{\circ}\text{C}$ f.s. (typical)
	Protection	Reverse polarity, short circuit
	Operating temperature	-20 ... +85° C
	EMC	EN61326-1:2013

WSxxP / WS100M / POSIWIRE®
with Absolute Magnetic Encoder
Analog Output



Signal Wiring	Signal	Plug connection	Cable connection [BN-WH-BU-BK-GY]	Cable connection [WH-GN-BN-YE-GY]
	Excitation +	1	brown	white
	Signal	2	white	green
	GND	3	blue	brown
	Do not connect!	4	black	yellow
	ZERO/END (Option PMU)	5	grey	grey

Connection

View to soldering side
of mating connector

CONN-M12-8F
A codification

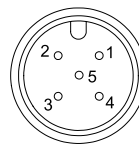

Signal wiring, double-channel, redundant, one connector	Signal	Channel	Plug connection M12, 8-pin	Cable connection
	Excitation +		1	1
Signal		1	2	brown
GND		1	3	green
ZERO/END (Option PMU)		1	4	yellow
Excitation +		2	5	grey
Signal		2	6	pink
GND		2	7	blue
ZERO/END (Option PMU)		2	8	red

Connection

View to soldering side
of mating connector

CONN-M12-8F
A codification

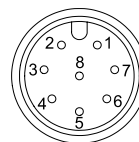

POSIWIRE®
with Incremental Optical Encoder
Incremental Output

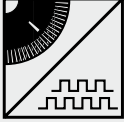

Signal conditioner PP530 Incremental 	Excitation voltage	5 ... 30 V DC
	Excitation current	25 mA typ. (w/o load), 200 mA max.
	Output frequency	200 kHz max.
	Output	Linedriver, Push-Pull, CMOS, TTL and HTL compatible
	Output current	30 mA max.
	Output voltage	Depends on the excitation voltage (e.g. to obtain TTL signals the excitation voltage must be 5 V). Compatible to EIA RS422/RS485
	Saturation voltage high/low	I _a < 10 mA, U _B 5 V/24 V: < 0.5 V I _a < 30 mA, U _B 5 V/24 V: < 1 V
	Stability (temperature)	±20 x 10 ⁻⁶ / K f.s. (sensor mechanism)
	Operation temperature	-10 ... +70 °C
	Storage temperature	-30 ... +80 °C
	Transition time positive edge	< 200 ns
	Transition time negative edge	< 200 ns
	Protection	Reverse polarity, short circuit *)
	EMC	EN 61326-1:2013

*) **Note:** Prevent unused output signals (e.g. \bar{A} , \bar{B} , \bar{Z}) from unintentionally being shorted with each other or any other voltage like ground, excitation + or shield. Isolate and secure unused output wires. Line driver may get damaged in case of shorted output for unlimited time.

Signal wiring	Signal	Plug connection	Cable connection
	Excitation +	1	white
	Excitation GND	2	brown
	Signal B (A+90°)	3	green
	Signal A	4	yellow
	Signal \bar{B}	5	grey
	Signal \bar{A}	6	pink
	Signal Z (reference pulse)	7	blue
	Signal \bar{Z}	8	red

Connection

View to soldering side of mating connector

- Check sensor type! -

CONN-M12-8F
A codification

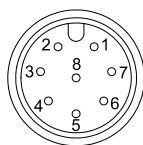

CONN-DIN-8F

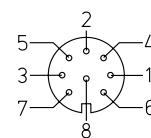

POSIWIRE®
with Incremental Optical Encoder
Incremental Output



Signal conditioner IE24LI und IE24HI Incremental 		IE24LI	IE24HI
	Excitation voltage	5 V DC ±10 %	10 ... 30 V DC
	Excitation current	100 mA max.	
	Output frequency	200 kHz max.	
	Output	Push pull and inverted signals	
	Output current	10 mA max.	
	Output voltage	Depending on the excitation voltage	
	Stability (temperature)	±20 x 10 ⁻⁶ / K f.s. (sensor mechanism)	
	Operating temperature	-20 ... +85 °C	
	Protection	Short circuit	
EMC	EN 61326-1:2013		

Signal wiring	Signal	Cable connection (WS31/42)
	Excitation +	Brown
	Excitation GND (0 V)	White
	Signal A	Green
	Signal \bar{A}	Yellow
	Signal B (A + 90°)	Grey
	Signal \bar{B}	Pink
	Signal Z (reference pulse)	Blue
	Signal \bar{Z}	Red

Signal conditioner IE41LI and IE41HI Incremental 		IE41LI	IE41HI
	Excitation voltage	5 V DC ±10 %	10 ... 30 V DC
	Excitation current	150 mA max. w/o load	
	Output frequency	300 kHz max.	200 kHz max.
	Output	RS422	Push-pull antivalent
	Output current	±30 mA max.	30 mA
	Output voltage	Depending on the excitation voltage	
	Stability (temperature)	±20 x 10 ⁻⁶ / K f.s. (sensor mechanism)	
	Operating temperature	-10 ... +70 °C	
	Protection against short circuit	One channel for 1 s	Yes
EMC	EN 61326-1:2013		

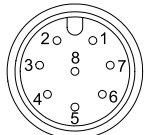
Signal wiring / connection	Signal	Plug connection WS10	Plug connection- WS12	View to soldering side of mating connector CONN-M12-8F A codification 
	Excitation +	1	1	
	Excitation GND (0 V)	2	2	
	Signal A	4	3	
	Signal \bar{A}	6	5	
	Signal B	3	4	
	Signal \bar{B}	5	6	
	Signal Z (reference pulse)	7	7	
	Signal \bar{Z}	8	8	

POSIWIRE®
with Incremental Optical Encoder
Incremental Output

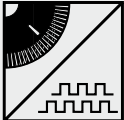

Signal conditioner PP24VC Incremental 	Interface	Push-pull line driver (24 V-HTL)
	Excitation voltage	10 ... 30 V DC
	Excitation current	150 mA max. w/o load
	Output frequency	300 kHz max.
	Output current	100 mA per channel
	Signal level	
	Ud High at Id=20 mA, Ub=24 V	≥21V
	Ud Low at Id=20 mA, Ub=24 V	≤2,8 V
	Transition time positive edge	<200 ns
	Transition time negative edge	<200 ns
	Stability (temperature)	±20 x 10 ⁻⁶ / K f.s. (sensor mechanism)
	Operating temperature	-20 ... +85 °C
	Protection	Reverse polarity, short circuit, overvoltage
	EMC	EN 61326-1:2013

Signal conditioner LD5VC Incremental 	Interface	Line driver RS422
	Excitation voltage	5 V DC ±10 %
	Excitation current	150 mA max. w/o load
	Output frequency	300 kHz max.
	Output current	20 mA per channel
	Signal level	
	Ud High at Id=20 mA	≥2,5V
	Ud Low at Id=20 mA	≤0,5 V
	Transition time positive edge	<100 ns
	Transition time negative edge	<100 ns
	Stability (temperature)	±20 x 10 ⁻⁶ / K f.s. (sensor mechanism)
	Operation temperature	-20 ... +85 °C
	Protection	Short circuit, overvoltage
	EMC	EN 61326-1:2013

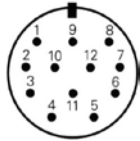
Signal wiring / connection	Signal	CONN-CONIN-12F, Plug connection	View to soldering side of mating connector CONN-CONIN-12F 
	Excitation +	12	
	Excitation GND (0 V)	10	
	Signal A	5	
	Signal \bar{A}	6	
	Signal B	8	
	Signal \bar{B}	1	
	Signal Z (reference pulse)	3	
	Signal \bar{Z}	4	
	Fault detection signal \bar{U}_{as}	7	
	Shield	Housing	

POSIWIRE®
with Potentiometer
SSI interface

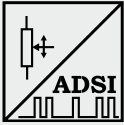

Signal conditioner ADSI16 [12/14] A/D converted synchronous serial 	Interface	EIA RS422, RS485, short-circuit proof
	Excitation voltage	11 ... 27 V DC
	Excitation current	200 mA max.
	Clock frequency	70 ... 500 kHz
	Code	Gray code, continuous progression
	Data format	24 Bit
	Delay between pulse trains	30 µs min.
	Resolution	16 bit (65536 counts) f.s.; optional 12 bit resp. 14 bit
	Stability (temperature)	±50 x 10 ⁻⁶ / °C f.s.
	Operating temperature	-20 ... +85 °C
	EMC	EN 61326-1:2013

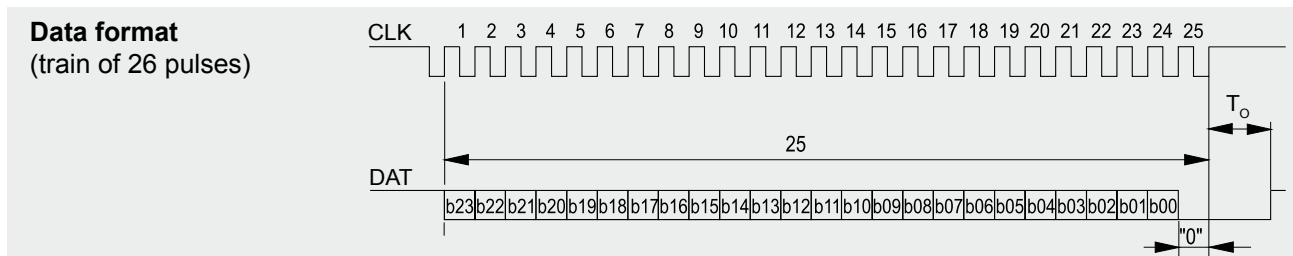

Transmission rate	Cable length	Baud rate
	< 50 m	< 300 kHz
	< 100 m	< 100 kHz

Signal wiring	Signal	Plug connection	Cable connection
	Excitation +	1	white
	Excitation GND (0 V)	2	brown
	CLOCK	3	green
	$\overline{\text{CLOCK}}$	4	yellow
	DATA	5	grey
	$\overline{\text{DATA}}$	6	pink
	Shield	not connected	-

Note:

Extension of the cable length will reduce the maximum transmission rate.

View to soldering side of mating connector - check connector type! -

CONN-M12-8F
A codification

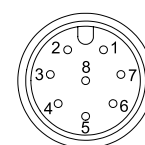

CONN-DIN-8F

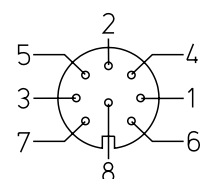

WSxxP / POSIWIRE®
with Magnetic Absolute Encoder
SSI interface

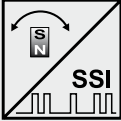

MSSI Synchronous serial SSI MSSI12/14/16*) 	Interface	EIA RS-422
	Excitation voltage	8 ... 36 V DC
	Excitation current	typ. 19/35 mA at 24/12 V max. 80 mA
	Clock frequency	100 kHz ... 500 kHz
	Code	Gray-Code, continuous progression
	Data format	24 Bit
	Delay between pulse trains	$T_o \geq 20 \mu\text{s}$ min.
	Stability (temperature)	$\pm 50 \times 10^{-6} / ^\circ\text{C}$ f.s. (typ.)
	Operating temperature	-20 ... +85 °C
	Protection	Short circuit, Reverse polarity
	EMC	EN61326-1:2013

*) MSSI12/14/16 replaces ADSI/ADSI14/ADSI16

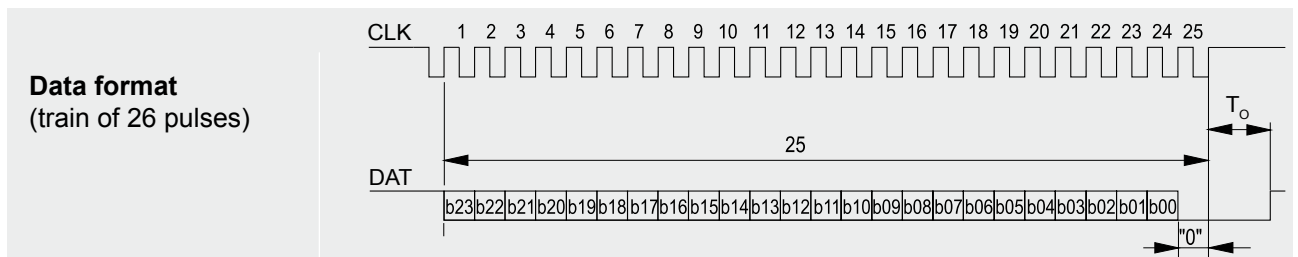

Transmission rate	Cable length	Baud rate
	50 m	100-400 kHz
	100 m	100-300 kHz

Note:
 Extension of the cable length will reduce the maximum transmission rate.

Signal wiring/ Connection	Signal	Plug connection	Cable connection
	Excitation +	1	white
	Excitation GND	2	brown
	CLOCK	3	green
	CLOCK	4	yellow
	DATA	5	grey
	DATA	6	pink
	-	7	blue
	-	8	red

View to soldering side of mating connector

CONN-M12-8F
 A codification

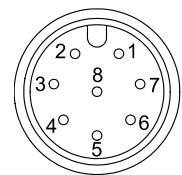

POSIWIRE®
with Optical Absolute Encoder
SSI interface



Signal conditioner TSSI2 Absolute encoder synchronous serial 	Interface	EIA RS422, RS485, short-circuit proof
	Excitation voltage	10 ... 30 V DC
	Excitation current	200 mA max.
	Clock frequency	100 kHz ... 1 MHz
	Code	Gray code, continuous progression
	Format	24 Bit
	Delay between pulse trains	12 to 35 µs
	Stability (temperature)	±20 x 10 ⁻⁶ / °C f.s. (sensor mechanism)
	Operating temperature	-20 ... +85 °C
	EMC	EN 61326-1:2013

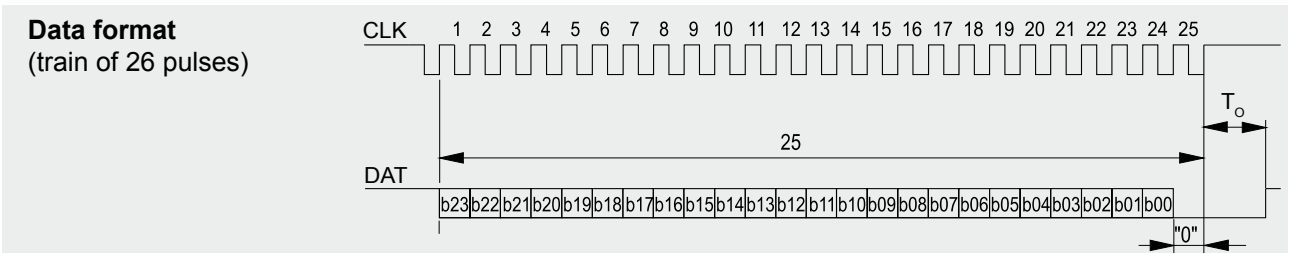

Transmission rate	Cable length	Baud rate
	50 m	100-1000 kHz
100 m	100-300 kHz	

Signal wiring	Signal	Plug connection
	Excitation +	7
	Excitation GND (0 V)	10
	CLOCK	8
	$\overline{\text{CLOCK}}$	9
	DATA	14
	$\overline{\text{DATA}}$	17
Direction ¹⁾	2	
Reset ²⁾	5	

Note:
Extension of the cable length will reduce the maximum transmission rate.

View to soldering side of mating connector
CONN-CONIN-17F

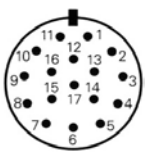

¹⁾ Permanent connecting to Excitation + will reverse the rotating direction.
²⁾ A positive edge >1 ms will reset the actual position value.

WSxxP / POSIWIRE®
with Optical Absolute Encoder
SSI interface



Signal conditioner HSSI Absolute encoder synchronous serial 	Excitation voltage	10 ... 30 V DC
	Excitation current	100 mA
	Interface	Standard SSI
	Lines / drivers	Clock and data / RS422
	Code	Gray
	Resolution	24 Bit
	Data format	24 Bit
	3 dB cutoff frequency	500 kHz
	Control input	$\overline{\text{Direction}}$
	Preset key	Zero adjustment with optical response
	Alarm output	Alarm bit (SSI option), warning bit
	Status LED	Green = OK, red = alarm
	Connection	12 pin male socket
	EMC	EN 61326-1:2013

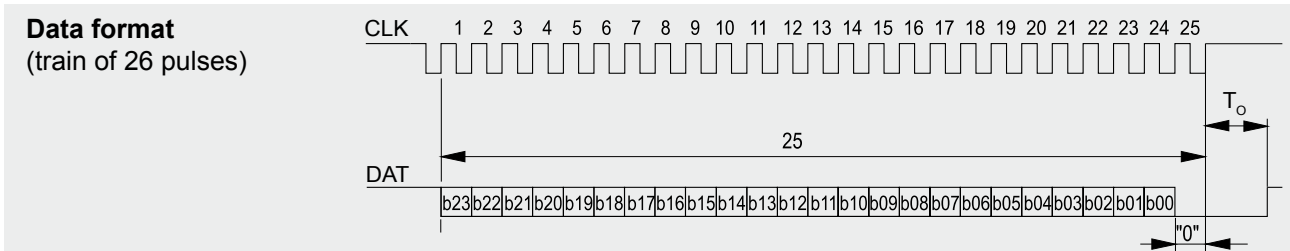

Transmission rate	Cable length	Baud rate	Note: Extension of the cable length will reduce the maximum transmission rate.
	< 50 m	< 400 kHz	
	< 100 m	< 300 kHz	
	< 200 m	< 200 kHz	
	< 400 m	< 100 kHz	

Signal wiring	Signal	Cable connection	Plug connection
	Excitation +	white	8
	Excitation GND (0 V)	brown	1
	CLOCK	yellow	3
	$\overline{\text{CLOCK}}$	green	11
	DATA	pink	2
	$\overline{\text{DATA}}$	grey	10
	$\overline{\text{Direction}}$ *	blue	5
	0 V Signal output	black	12

* unconnected or Excitation + = cw increasing code
0 V = cw decreasing code

View to soldering side of mating connector

CONN-CONIN-12F

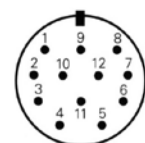

WSxxP / POSIWIRE®
with Magnetic Absolute Encoder
CANopen



MCANOP CANopen 	Communication profile	CANopen CiA 301 V 4.02, Slave
	Encoder profile	Encoder CiA 406 V 3.2
	Configuration services	Layer Setting Service (LSS), CiA Draft Standard 305 (transmission rate, Node ID)
	Error Control	Node Guarding, Heartbeat, Emergency Message
	Node ID	Adjustable via LSS; default: 127
	PDO	3 TxPDO, 0 RxPDO, no linking, static mapping
	PDO Modes	Event-/Time triggered, Remote-request, Sync cyclic/acyclic
	SDO	1 server, 0 client
	CAM	8 cams
	Certified	Yes
	Transmission rates	50 kbit to 1 Mbit, adjustable via LSS; default: 125 kbit
	Bus connection	M12 connector, 5 pins
	Integrated bus terminating resistor	120Ω (adjustable by the customer)
Bus, galvanic isolated	No	

Specifications	Excitation voltage	8 ... 36 V DC
	Excitation current	Typ. 20/40 mA for 24/12 V, max. 80 mA
	Measuring rate	1 kHz (asynchronous)
	Stability (temperature)	±50 x 10 ⁻⁶ / °C f.s.
	Repeatability	1 LSB
	Operating temperature	-20 ... +85 °C
	Protection	Reverse polarity, short circuit
	EMC	According to EN 61326-1:2013

Signal wiring	Signal	Plug connection
	Shield	1
	Excitation +	2
	GND	3
	CAN-H	4
	CAN-L	5

View to soldering side of mating connector

CONN-M12-5F
 A codification

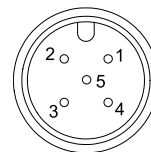

Setup



WARNING



NOTICE

Warning notice

- Changing parameters may cause unexpected machine movement.
- Changing parameters may influence dependent parameters
- e.g. changing the resolution may have influence on position of CAM switches.
- Precautions have to be taken to avoid damage to human and machine parts!
- Change parameters only when machine is in a safe condition!

Before connecting the sensor to the CAN-Bus the devices have to be checked for correct bitrate and unique node-IDs. Both parameters are configurable by Layer-Setting-Service (LSS) or by Service Data Object (SDO). After power-on the sensor will enter pre-operational state and send a boot-up message being ready for configuration by Service Data Objects. Parameters configured by the user can be stored nonvolatile by SAVE command. On receiving „NMT-Node-Start“ the sensor transits to operational state and starts process data transmission. When „Auto-Start“ is configured the sensor will automatically transit to operational after boot-up without a need for the Node-Start message.

Node monitoring is supported by Node Guarding and Heartbeat protocol. Node Guarding implements cyclic querying of the node status by the NMT-Master within the guard time window. The Heartbeat protocol provides automatic transmission of the node status (heartbeat message) by the slave within producer heartbeat time window.

Following the CAN example protocols included in this manual the sensor may be used without CANopen master device.

Service Data Object (SDO) COB-Id

Service data objects (SDO) provide a peer to peer communication between master and slave. The communication object identifier (COB) of the SDO is defined by the Node-Id.

SDO	COB-Id	Default COB-Id
Master to Slave	600h + Node-Id	67Fh
Slave to Master	580h + Node-Id	5FFh

Process Data Object (TPDO)

Real time data transfer is provided by Process Data Objects (PDO). The PDO mapping is fixed. The PDO COB-Id is by default setting derived from the Node-Id (Predefined Connection Set) but may be changed to application specific values by object PDO COB-Id 1800..1803 Sub-Index-1. DLC defines the length of the data field.

COB-Id	DLC	Data Frame	
		Byte0	Byte7
180h + Node-Id	length	Data Frame max 8 Byte	

Transmission behaviour of TPDO-1, -2, -4 is configurable by object PDO Communication Parameter 1800, 1801, 1803 sub-indices -1, -2, -3 and -5.

Transmission type example for TPDO-1	COB-Id 1800-1	Transmission Type 1800-2	Inhibit Time 1800-3	Event Timer [ms] 1800-5
Cyclic Asynchronous		FEh	1 .. 07FFFh	1 .. 07FFFh
Change of State		FEh	1 .. 07FFFh	0
Synchronous		N = 1 .. 240		-
Disable TPDO Enable TPDO	80 00 xx xx 00 00 xx xx	-		-

Transmission type «cyclic asynchronous» triggers TPDO-transmission periodically with a time period defined by the event timer.

Transmission type «change of state» will be enabled If the event timer is set to «0». This will trigger TPDO-transmission on change of the position value where «Inhibit time» defines a minimum time delay between consecutive TPDOs.

In «synch mode» a TPDO is transmitted on reception of a number of one or multiple SYNC commands.

Enable or disable a TPDO by setting Bit 31 of the COB-Id '0' resp. '1' (Default: «0» Enabled).

Object Dictionary Communication Profile CiA 301

Object	Index [hex]	Sub-index	Access	Type	Default	Value Range / Note
Device type	1000	0	ro	U32	80196h	encoder profile ,406'
Error register	1001	0	ro	U8	0	
COB-ID-Sync	1005	0	rw	U32	80	
Manufacturer device name	1008	0	ro	String	-	
Manufacturer hardware version	1009	0	ro	String	-	
Manufacturer software version	100A	0	ro	String	-	
Guard time	100C	0	rw	U16	0	0 .. 7FFFh
Life time factor	100D	0	rw	U8	0	0 .. FFh
Save Settings	1010	1	w	U32	-	„save“ (65766173h)
Load Manufacturer Settings	1011	1	w	U32	-	„load“ (64616F6Ch)*
COB-ID-EMCY	1014	0	ro	U32	FFh	NodeID+80h
Producer heartbeat time	1017	0	rw	U16	0	0 .. 7FFFh
Identity Object VendorID	1018	1	ro	U32	252h	
Identity Object Product Code		2	ro	U32	-	
Identity Object Revision number		3	ro	U32	-	
Identity Object Serial number		4	ro	U32	-	
COB-ID Server->Client	1200	1	ro	U32	67Fh	- SOD
COB-ID Client-> Sever	1200	2	ro	U32	5FFh	- SDO
PDO1 COB-ID	1800	1	rw	U32	1FFh	181h .. 1FFh
PDO1 Transmission-Type		2	rw	U8	FEh	0 .. FFh
PDO1 Inhibit time		3	rw	U16	0	0 .. 7FFFh
PDO1 Event timer		5	rw	U16	64h	0 .. 7FFFh
PDO2 COB-ID	1801	1	rw	U32	2FFh	281h .. 2FFh
PDO2 Transmission-Type		2	rw	U8	1	0 .. FFh
PDO2 Inhibit time		3	rw	U16	0	0 .. 7FFFh
PDO2 Event timer		5	rw	U16	0	0 .. 7FFFh
PDO4 COB-ID	1803	1	rw	U32	4FFh	381h .. 3FFh
PDO4 Transmission-Type		2	rw	U8	FEh	0 .. FFh
PDO4 Inhibit time		3	rw	U16	0	0 .. 7FFFh
PDO4 Event timer		5	rw	U16	0	0 .. 7FFFh
TPDO1-Mapped Object	1A00	1	ro	U32	60040020h	
TPDO2-Mapped Object	1A01	1	ro	U32	60040020h	
TPDO4-Mapped Object	1A03	1	ro	U32	63000108h	
NMT-Startup	1F80	0	rw	U32	0	0, 8

*) Reset to Manufacturer Default Setting, Bitrate und Node ID not affected

Device profile „Linear Encoder“ CiA 406
Single and redundant Devices

Object	Index	Sub-Index	Access	Default	Value range / note
Manufacturer specific					
Node ID	2000	0	rw	127 *)	1...127
Bitrate	2010	0	rw	4 *)	0...4, 6
Hysteresis (change of state)	2040	0	rw	10	0 ... 1000
Termination resistor	2050	0	rw	0	0 (off) / 1 (on)
Filter	2102	0	r/w	1	1...255
Linear-Encoder CiA406					
Operating Parameters	6000	0	rw	0	Bit select
Total Measuring Range	6002	0	rw	-	Measuring range in 10 mm-Steps
Preset Value	6003	0	rw	0	
Position Value	6004	0	ro	-	
Measuring Step	6005	1	rw	10 ³ nm	10 ³ .. 10 ⁶ nm
Cyclic Timer	6200	0	rw	100	10 ... 7FFFh
Profile SW Version	6507	0	ro		
Serial Number	650B	0	ro		
CAM CiA406					
Cam state register	6300	0	ro	0	
Cam enable register	6301	0	rw	0	
Cam polarity register	6302	0	rw	0	
Cam 1-8 low limit	6310.. 6317	1	rw	0	
Cam 1-8 high limit	6320.. 6327	1	rw	0	
Cam 1-8 hysteresis	6330.. 6337	1	rw	0	

*) For dual redundant devices: Always configure Baud-Rates to the same value and the Node-Ids to different values.

Operating Parameters (Object 6000)

15	4	3	2	1	0
-	-	-	-	-	md	sfc	-	-
msb								lsb

md = 0/1

Measuring direction in / out

sfc = 0/1

Scaling function disabled/enabled

Process Data Object (TPDO) Mapping

TPDO	COB-Id	DLC	Data Frame							
			Byte0							Byte7
TPDO-01	180h +Node-Id	4	4 Byte Position Data							
			(LSB)	(MSB)				
TPDO-02	280h +Node-Id	4	4 Byte Position Data							
			(LSB)	(MSB)				
TPDO-04	480h +Node-Id	1	CAM State							

CAM State Data Format

8 Bit CAM State Register							
b7	b6	b5	b4	b3	b2	b1	b0
CAM 8	CAM 7	CAM 6	CAM 5	CAM 4	CAM 3	CAM 2	CAM 1

TPDO Default Settings

TPDO	Default COB-Id	Default Transmission Type
TPDO-01: Position Data, 4 Byte	1FFh	Event Timer 100ms (FE, TI=0)
TPDO-02: Position Data, 4 Byte	2FFh	Sync Mode
TPDO-04: CAM Status, 1 Byte	4FFh	Change of State Mode

Baud Rate (Object 2010)

Baud Rate Index	Baud Rate [kbit/s]
0	1000
1	800
2	500
3	250
4	125
6	50

Examples

Example protocols are prepared using the IXXAT USB-to-CAN PC-Interface with CAN-Monitor „miniMon“ (IXXAT Automation GmbH, D-88250 Weingarten). These examples enable the user to configure and to run the CANopen slaves from a host PC without using a CANopen master ECU. The miniMon-screen has the configuration and status window at left side, a receive message window and a transmit message window below.

Configuration Example 1 - screenshot

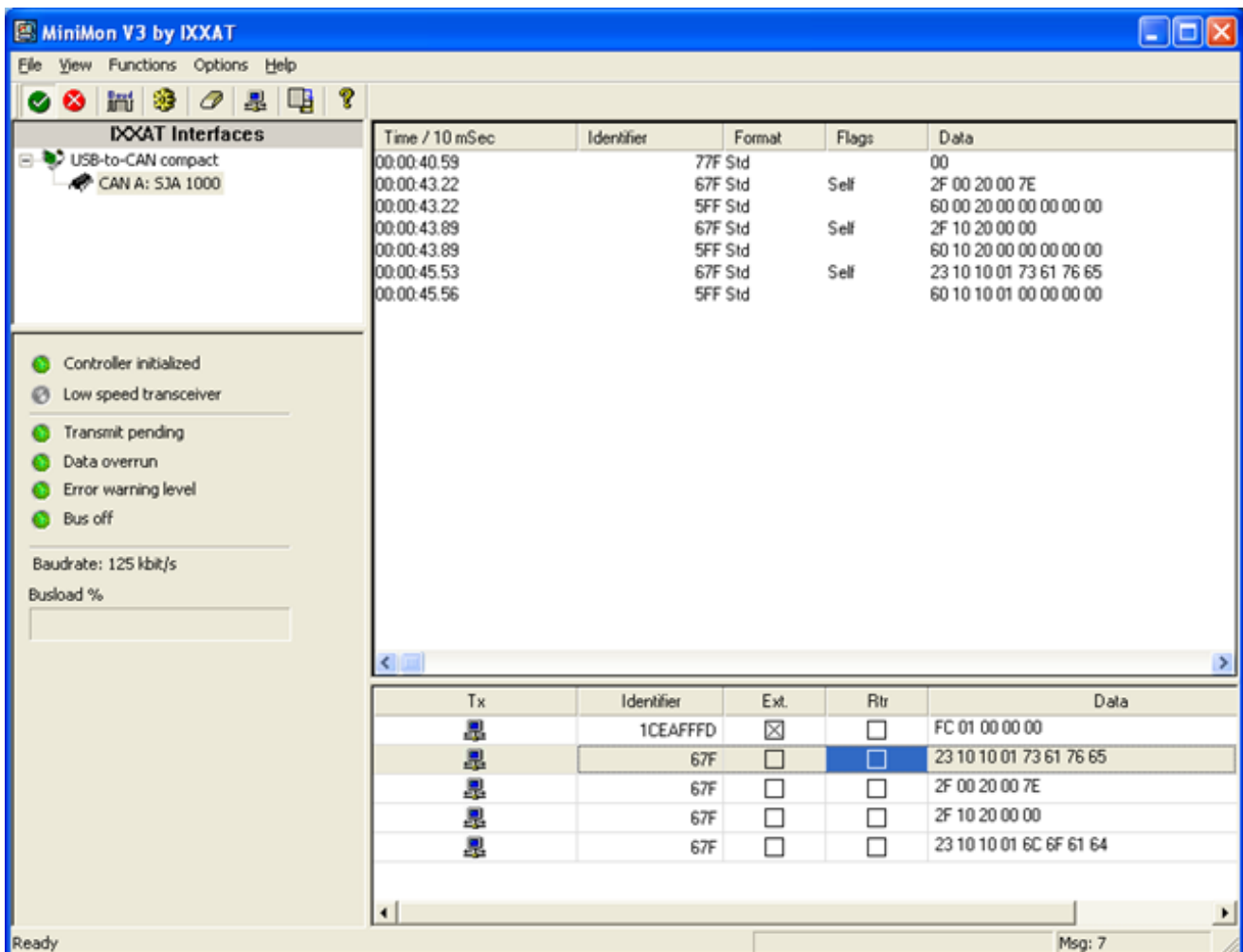

The screenshot shows the MiniMon V3 by IXXAT software interface. The window title is "MiniMon V3 by IXXAT". The menu bar includes "File", "View", "Functions", "Options", and "Help". The toolbar contains various icons for control and help.

IXXAT Interfaces

- USB-to-CAN compact
 - CAN A: SJA 1000

Status Indicators:

- Controller initialized
- Low speed transceiver
- Transmit pending
- Data overrun
- Error warning level
- Bus off

Baudrate: 125 kbit/s
 Busload %

Receive Message Log:

Time / 10 mSec	Identifier	Format	Flags	Data
00:00:40.59	77F Std			00
00:00:43.22	67F Std		Self	2F 00 20 00 7E
00:00:43.22	5FF Std			60 00 20 00 00 00 00 00
00:00:43.89	67F Std		Self	2F 10 20 00 00
00:00:43.89	5FF Std			60 10 20 00 00 00 00 00
00:00:45.53	67F Std		Self	23 10 10 01 73 61 76 65
00:00:45.56	5FF Std			60 10 10 01 00 00 00 00

Transmit Message Log:

Tx	Identifier	Ext.	Rtr	Data
<input type="checkbox"/>	1CEAFFFD	<input checked="" type="checkbox"/>	<input type="checkbox"/>	FC 01 00 00 00
<input type="checkbox"/>	67F	<input type="checkbox"/>	<input checked="" type="checkbox"/>	23 10 10 01 73 61 76 65
<input type="checkbox"/>	67F	<input type="checkbox"/>	<input type="checkbox"/>	2F 00 20 00 7E
<input type="checkbox"/>	67F	<input type="checkbox"/>	<input type="checkbox"/>	2F 10 20 00 00
<input type="checkbox"/>	67F	<input type="checkbox"/>	<input type="checkbox"/>	23 10 10 01 6C 6F 61 64

Ready Msg: 7



Configuration Example 1 - detailed explanation

The example shows the Sensor responding on POWER ON with the Boot-Up message. By SDO message the node-Id and the baud rate will be changed to 7Eh and 1000kbit/s. Finally the host sends an SDO „SAVE“ to store the configuration nonvolatile.

Note: Changes of of node-Id and baud rate will become effective on next POWER ON sequence. So the SAVE command has to address the old SDO-COB-Id.

Screen Shot Explanation:

Time / 10 mSec	Identifier	Format	Flags	Data
00:00:40.59	<i>Boot-Up message</i>	77F StD		00
00:00:43.22	<i>Set node Id to 7E</i>	67F StD	Self	2F 00 20 00 7E
00:00:43.22	<i>Response</i>	5FF StD		60 00 20 00 00 00 00 00
00:00:43.89	<i>Set baud rate to 1000kbit/s</i>	67F StD	Self	2F 10 20 00 00
00:00:43.89	<i>Response</i>	5FF StD		60 10 20 00 00 00 00 00
00:00:45.53	<i>SAVE</i>	67F StD	Self	23 10 10 01 73 61 76 65
00:00:45.56	<i>Response</i>	5FF StD		60 10 10 01 00 00 00 00

Configuration Example 2 - screenshot

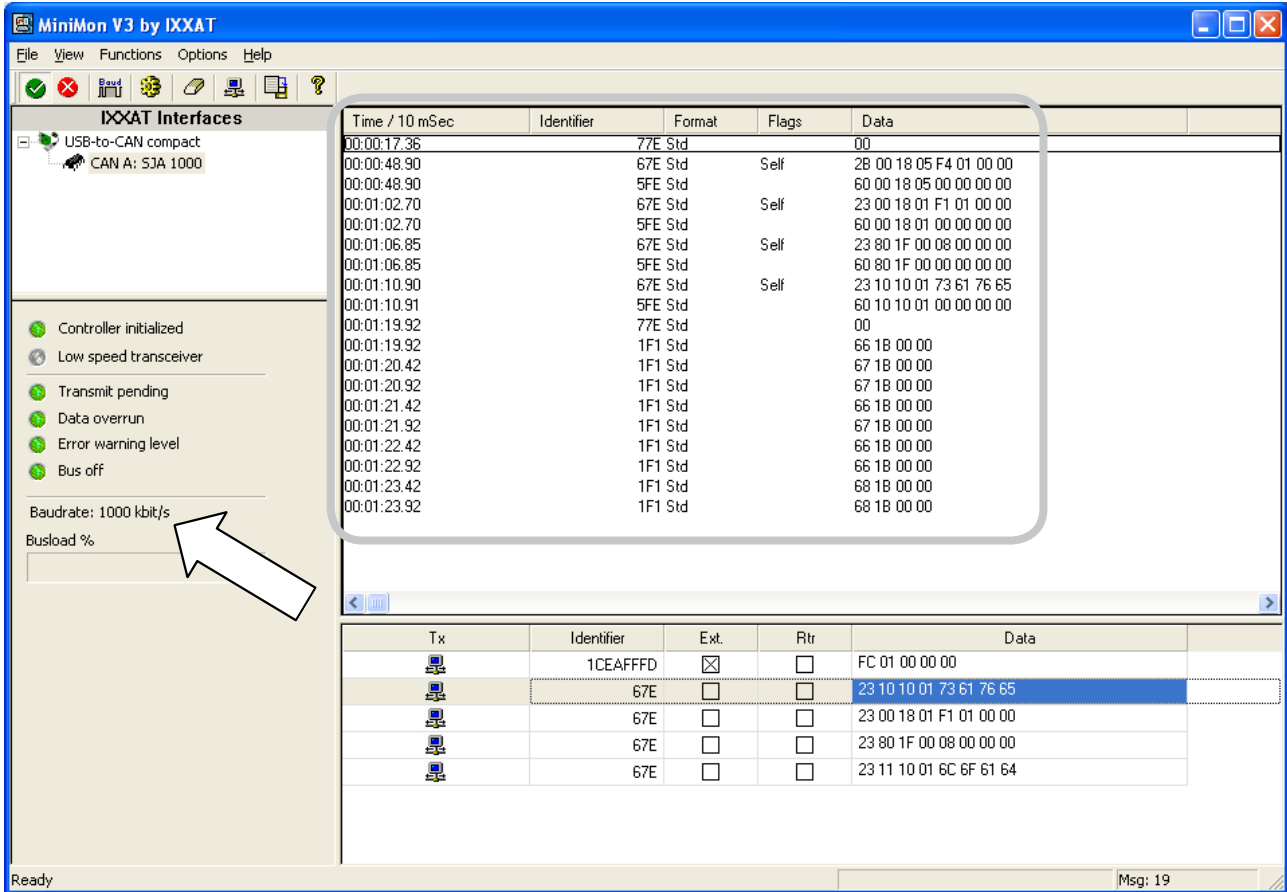

The screenshot shows the MiniMon V3 by IXXAT software interface. The main window displays a list of CAN bus messages with the following columns: Time / 10 mSec, Identifier, Format, Flags, and Data. A white arrow points to the 'Baudrate: 1000 kbit/s' setting in the left-hand configuration panel.

Time / 10 mSec	Identifier	Format	Flags	Data
00:00:17.36		77E Std		00
00:00:48.90		67E Std	Self	26 00 18 05 F4 01 00 00
00:00:48.90		5FE Std		60 00 18 05 00 00 00 00
00:01:02.70		67E Std	Self	23 00 18 01 F1 01 00 00
00:01:02.70		5FE Std		60 00 18 01 00 00 00 00
00:01:06.85		67E Std	Self	23 80 1F 00 08 00 00 00
00:01:06.85		5FE Std		60 80 1F 00 00 00 00 00
00:01:10.90		67E Std	Self	23 10 10 01 73 61 76 65
00:01:10.91		5FE Std		60 10 10 01 00 00 00 00
00:01:19.92		77E Std		00
00:01:19.92		1F1 Std		66 18 00 00
00:01:20.42		1F1 Std		67 18 00 00
00:01:20.92		1F1 Std		67 18 00 00
00:01:21.42		1F1 Std		66 18 00 00
00:01:21.92		1F1 Std		67 18 00 00
00:01:22.42		1F1 Std		66 18 00 00
00:01:22.92		1F1 Std		66 18 00 00
00:01:23.42		1F1 Std		68 18 00 00
00:01:23.92		1F1 Std		68 18 00 00

Tx	Identifier	Ext.	Rtr	Data
	1CEAFFFD	<input checked="" type="checkbox"/>	<input type="checkbox"/>	FC 01 00 00 00
	67E	<input type="checkbox"/>	<input type="checkbox"/>	23 10 10 01 73 61 76 65
	67E	<input type="checkbox"/>	<input type="checkbox"/>	23 00 18 01 F1 01 00 00
	67E	<input type="checkbox"/>	<input type="checkbox"/>	23 80 1F 00 08 00 00 00
	67E	<input type="checkbox"/>	<input type="checkbox"/>	23 11 10 01 6C 6F 61 64

Configuration Example 2 - detailed explanation

The message window shows the slave responding on POWER ON with the Boot-Up message on new node-id 7Eh. Event timer of PDO1 is changed to 500ms and COB-Id of PDO1 is changed to 1F1h. Finally „Autostart“ is activated (automatic transition to operational) and the configuration stored nonvolatile with „SAVE“. On POWER OFF / POWER ON the slave starts sending PDOs asynchronously with the new COB-Id after the Boot-Up message.

Screenshot explanation:

Time / 10 mSec	Identifier	Format	Flags	Data
00:00:17.36	<i>Boot-Up Message</i>	77E Std		00
00:00:48.90	<i>Set PDO1 Event Timer 500</i>	67E Std	Self	2B 00 18 05 F4 01 00 00
00:00:48.90	<i>Response</i>	5FE Std		60 00 18 05 00 00 00 00
00:01:02.70	<i>Set PDO1 COB-Id to 1F1</i>	67E Std	Self	23 00 18 01 F1 01 00 00
00:01:02.70	<i>Response</i>	5FE Std		60 00 18 01 00 00 00 00
00:01:06.85	<i>Set Autostart</i>	67E Std	Self	23 80 1F 00 08 00 00 00
00:01:06.85	<i>Response</i>	5FE Std		60 80 1F 00 00 00 00 00
00:01:10.90	<i>SAVE</i>	67E Std	Self	23 10 10 01 73 61 76 65
00:01:10.91	<i>Response .. POWER OFF</i>	5FE Std		60 10 10 01 00 00 00 00
00:01:19.92	<i>Boot Up on POWER ON</i>	77E Std		00
00:01:19.92	<i>Cyclic PDO Transfer</i>	1F1 Std		66 1B 00 00
00:01:20.42	<i>on Power On</i>	1F1 Std		67 1B 00 00
00:01:20.92	...	1F1 Std		67 1B 00 00
00:01:21.42	...	1F1 Std		66 1B 00 00
00:01:21.92	...	1F1 Std		67 1B 00 00
00:01:22.42	...	1F1 Std		66 1B 00 00
00:01:22.92	...	1F1 Std		66 1B 00 00
00:01:23.42	...	1F1 Std		68 1B 00 00
00:01:23.92	...	1F1 Std		68 1B 00 00

CAM function

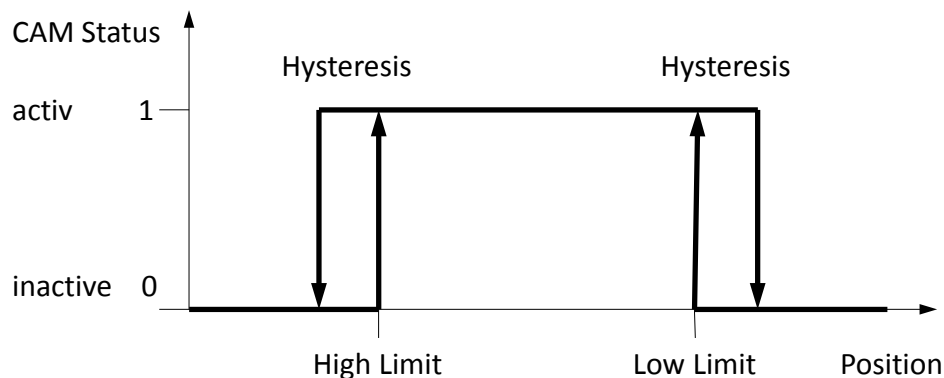

Signal wiring / connection	Signal	Plug connection	Cable connection
	Shield	1	braid
	Excitation +	2	brown
	GND	3	white
	CAN-H	4	blue
	CAN-L	5	black

View to sensor connector

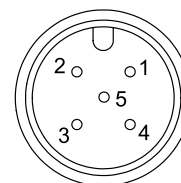

CAN bus wiring

Connect the device by a T-connector to the CAN trunk line. Total length of stubs should be minimized. Do not use single stub lines longer than 0.5 m. Connect terminating resistors 120 Ohm at both ends of the trunk line.

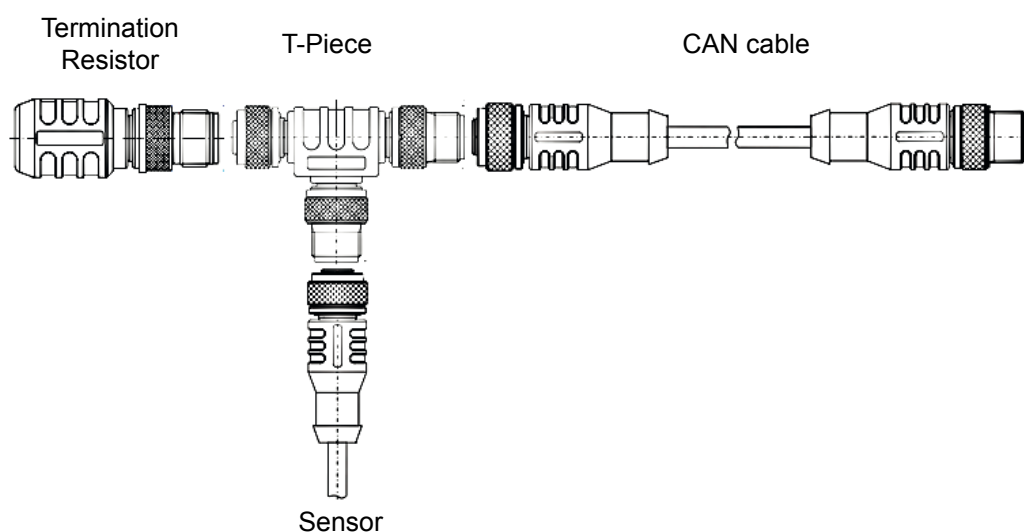

WSxxP / POSIWIRE®
with Magnetic Absolute Encoder
CAN SAE J1939



MCANJ1939 CAN SAE J1939 	CAN specification	ISO 11898, Basic and Full CAN 2.0 B	
	Transceiver	24V-compliant, not isolated	
	Communication profile	SAE J1939	
	Baud rate	250 kbit/s	
	Internal termination resistor	120 Ω (adjustable by the customer)	
	Address	Default 247d, configurable	
	NAME Fields	Arbitrary address capable	1
Industry group		0	Global
Vehicle system		7Fh (127d)	Non specific
Vehicle system instance		0	
Function		FFh (255d)	Non specific
Function instance		0	
ECU instance		0	
Manufacturer		145h (325d)	Manufacturer ID
Identity number		0nnn	Serial number 21 bit
Parameter Group Numbers (PGN)	Configuration data	PGN EF00h	Proprietary-A (PDU1 peer-to-peer)
	Process data	PGN FFnnh	Proprietary-B (PDU2 broadcast); nn Group Extension (PS) configurable
Specifications	Excitation voltage	8 ... 36 V DC	
	Excitation current	Typ. 20/40 mA for 24/12 V, max. 80 mA	
	Measuring rate	1 kHz (asynchronous)	
	Stability (temperature)	±50 x 10 ⁻⁶ / °C f.s.	
	Repeatability	1 LSB	
	Operating temperature	-20 ... +85 °C	
	Protection	Reverse polarity, short circuit	
	Dielectric strength	1 kV (V AC, 50 Hz, 1 min.)	
	EMC	EN 61326-1:2013	

Signal wiring	Signal	Plug connection
		Shield
	Excitation +	2
	GND	3
	CAN-H	4
	CAN-L	5

View to soldering side of mating connector

CONN-M12-5F
A codification

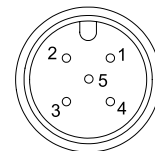



WARNING

Warning notice

- Changing the parameters can cause a sudden step of the instantaneous value and can result in unexpected machine (re)actions!
- Precautions to prevent danger for man or machine are necessary!
- Execute parametrizing at standstill of the machine only!

Setup

Node-ID

The default Node-ID the sensor will claim on power up is user or factory configurable. The user can configure by "Commanded Address" service according to the J1939 standard or by Peer-to-Peer message as described below.

User configuration

User accessible parameters including node-id may be configured by peer-to-peer proprietary A message PGN 0EF00h. The parameters are accessed by byte-index and read/write operations coded in the data frame. The slave will return the data frame including the acknowledge code. Parameter values will be effective immediatly. On execution of "Store Parameters" the configuration is saved nonvolatile.

Peer-to-peer message (PGN 0x00EF00), send/receive format

PGN		8 Byte data frame							
PGN _{HIGH}	PGN _{LOW} (Node-ID)	Index	Rd/Wr	0	Ack	4-Byte Data			

Request: Control Unit → Sensor

→	0EFh	dd	i	0/1	0	0	LSB	MSB
---	------	----	---	-----	---	---	-----	----	----	-----

Response: Control Unit ← Sensor

←	0EFh	cc	i	0/1	0	a	LSB	MSB
---	------	----	---	-----	---	---	-----	----	----	-----

- a: Acknowledge codes:
 0: Acknowledge, 81: Read only parameter, 82: Range overflow,
 83: Range underflow, 84: Parameter does not exist
- dd: Sensor Node-ID (Default 0F7h, 247d)
- cc: Control-Unit Node-ID

Configuration examples

Example: Set Transmit Cycle to 10ms, Index 31, Node-ID 247d (F7h)

	PGN _{HIGH}	PGN _{LOW}	8 Byte data frame							
→	0EFh	F7h	1Fh	01h	00	00	0Ah	00	00	00
←	0EFh	cc	1Fh	01h	00	00	0Ah	00	00	00

Example: Read Transmit Cycle value, Index 31

→	0EFh	F7h	1Fh	00	00	00	00	00	00	00
←	0EFh	cc	1Fh	00	00	00	0Ah	00	00	00

Example: Store Parameters permanently, Index 28

→	0EFh	F7h	1Ch	01h	00	00	65h	76h	61h	73h
←	0EFh	cc	1Ch	01h	00	00	65h	76h	61h	73h

Reload factory defaults, Index 29

→	0EFh	F7h	1Dh	01h	00	00	64h	61h	6Fh	6Ch
←	0EFh	cc	1Dh	01h	00	00	64h	61h	6Fh	6Ch

Example: Broadcast (PGN_{Low} = 0FFh - Reload factory defaults of all sensors, Index 29

→	0EFh	0FFh	1Dh	01h	00	00	64h	61h	6Fh	6Ch
←	0EFh	cc	1Dh	01h	00	00	64h	61h	6Fh	6Ch

Encoder - Parameters

Parameter	Index [dec]	Default	Range / Selection	Unit	Read / Write
Control					
Node ID	20	247	128 ... 247		rd/wr ¹⁾
Baude rate	21	3 (250kB)	-		rd
Termination resistor	22	0	0/1 (off/on)		rd/wr ²⁾
Store parameters	28	-	"save" ³⁾		wr
Reload factory defaults	29	-	"load" ³⁾		wr ²⁾
Communication					
Transmit mode	30	0	0 timer 1 request 2 event		rd/wr
Transmit cycle	31	100	10 ... 65535	ms	rd/wr
PGN Group Extension	32	0	0 ... 255		rd/wr
Event mode hysteresis	38	0	0 ... 16383	steps	rd/wr
Process data byte order	39	0	0 little / 1 big endian		rd/wr
Measurement					
Code sequence	70	0	0 CW 1 CCW		rd/wr
Measuring step	73	2 ¹⁴	1 ... 2 ¹⁴	µm	rd/wr
Preset	74	0	0 ... 2 ¹⁴ - 1	steps	rd/wr
Averaging filter	77	1	1 ... 255		rd/wr
Identification					
SW Version	198	-	4 bytes	number	rd
Serial number	199	-	4 bytes	number	rd
Identity number	200	-	21 bit	number	rd

1) Write access to index 20 (change of node ID) is effective immediately and initiates address claiming

2) Effective on next power-up

3) „save“ MSB...LSB: 73h, 61h, 76h, 65h
 „load“ MSB...LSB: 6Ch, 6Fh, 61h, 64h

Broadcast access by PGN_{Low} = 0FFh addresses the specified index of all sensors

Depending on configuration ordered default settings may be different, refer to ASM homepage.

Process data

Process data are transmitted by broadcast proprietary-B-Message PGN 0x00FFxx where the low byte is configurable.

Data field of process data

B7	B6	B5	B4	B3	B2	B1	B0
Error				Position value			
Byte ^{*)}				MSB			LSB

^{*)} Error codes: 0 = no error, 1 = error

WSxxP / POSIWIRE®
with Magnetic Absolute Encoder
CAN SAE J1939



Signal wiring	Signal	Plug connection	Cable connection
	Shield	1	braid
	Excitation +	2	white
	GND	3	brown
	CAN-H	4	blue
	CAN-L	5	black

View to sensor connector

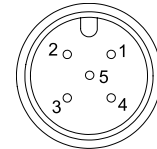

CAN Bus wiring

Connect the device by a T-connector to the CAN trunk line. Total length of stubs should be minimized. Do not use single stub lines longer than 0.5 m. Connect terminating resistors 120 Ohm at both ends of the trunk line.

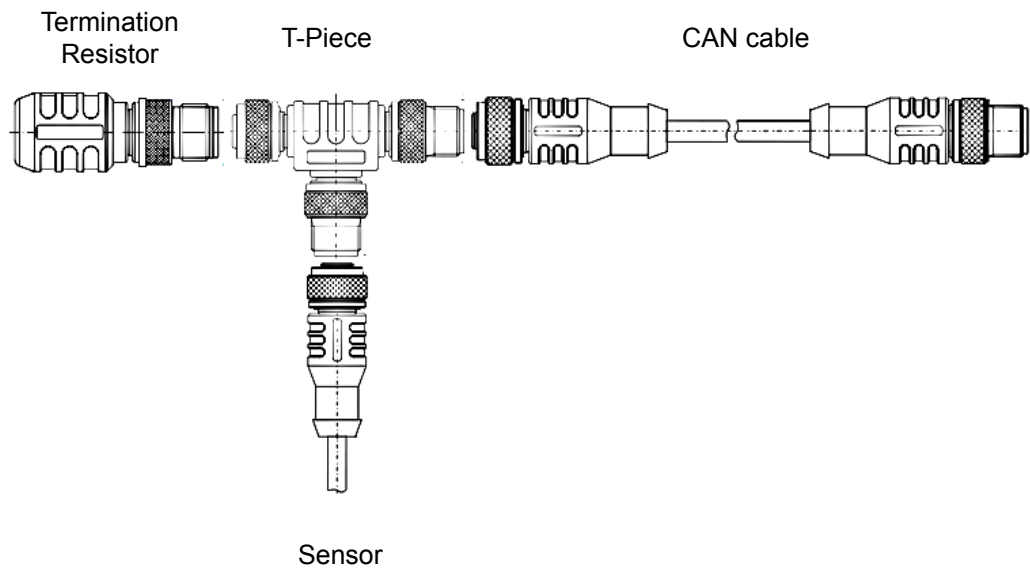

WSxxP / POSIWIRE®
with Magnetic Absolute Encoder
CAN SAE J1939



Interface HCAN/HCANOP Absolute encoder CANopen/CAN Layer 2 	Excitation voltage	10 ... 30 V DC
	Excitation current	250 mA
	Interface	CAN highspeed according to ISO/DIS 11898
	Protocol	CANopen according DS301 with encoder profile DSP406, programmable encoder according class C2
	Resolution	12 (10 ... 14) + 12 bit
	Output code	Binary
	Data refresh	Every millisecond (selectable), on request
	Baud rate	Selectable 10 up to 1000 kbit/s
	Base identifier	Selectable via DIP switch
	Programmability	CANopen: direction, resolution, preset, offset CAN L2: direction, limit values
	Integrated special functions	CANopen: velocity, acceleration, rotary axis, limit values CAN L2: direction, limit values
	Connection	Bus cover with T manifold
	EMC	EN 61326-1:2013

Signal wiring	Signal	Cable terminal no. (bus cover)
	U _B in	1
	0V in	2
	CAN in –	3
	CAN in +	4
	CAN GND in	5
	CAN GND out	6
	CAN out +	7
	CAN out –	8
	0V out	9
	U _B out	10

Notes: Download of the manual and the configuration file of the encoder at the ASM website www.asm-sensor.com in the “Downloads” section (hcanop_de_en.zip).

The encoder parameters must be set before operation!

In the subsequent electronics the 12 bit LSB resolution of the data sheet must be considered as a scaling factor.

If the encoder is set to another single turn resolution, the scaling factor is the result of the resolution of the cable drum of the WS sensor per revolution and the resolution of the encoder.

Example:

WS19KT-15000 with angle encoder 13 bit/revolution, distance/revolution 600 mm

Scaling factor: $600 \text{ mm} / 2^{13} = 600 \text{ mm} / 8192 = 0,073242 \text{ mm} / \text{Bit}$ (= LSB resolution)

Interface HDEV Absolute encoder DeviceNet 	Excitation voltage	10 ... 30 V DC
	Excitation current	250 mA
	Interface	CAN highspeed according to ISO/DIS 11898 CAN specification 2.0 A (11 bit identifier)
	Protocol	DeviceNet according rev. 2.0, programmable encoder
	Resolution	12 (10 ... 14) + 12 bit
	Output code	Binary
	MAC-ID	Selectable via DIP switch
	Date refresh	Every 5 ms
	Baud rate	Selectable via DIP switch: 125 kBaud, 250 kBaud, 500 kBaud
	Programmability	Resolution, preset, direction
	Bus terminating resistor	Selectable via DIP switch
	Connection	Bus cover with T manifold
	EMC	EN 61326-1:2013
	Recommended transmission	Characteristic impedance
Operating capacity		< 30 pF
Loop resistance		< 110 Ω/km
Wire diameter		> 0.63 mm
Wire width		> 0.34 mm ²
Transmission rate	Segment length	Kbit/s
	500 m	125
	250 m	250
	100 m	500
Signal wiring	Signal	Cable terminal no. (bus cover)
	U _B in	1
	0V in	2
	CAN-L	3
	CAN-H	4
	Drain	5
	Drain	6
	CAN-H	7
CAN-L	8	

Notes: Download of the manual and the configuration file of the encoder at the ASM website www.asm-sensor.com in the "Downloads" section (hdev_de_en.zip).

The encoder parameters must be set before operation!

In the subsequent electronics the 12 bit LSB resolution of the data sheet must be considered as a scaling factor.

If the encoder is set to another single turn resolution, the scaling factor is the result of the resolution of the cable drum of the WS sensor per revolution and the resolution of the encoder.

Example:

WS19KT-15000 with angle encoder 13 bit/revolution, distance/revolution 600 mm

Scaling factor: $600 \text{ mm} / 2^{13} = 600 \text{ mm} / 8192 = 0,073242 \text{ mm} / \text{Bit}$ (= LSB resolution)

POSIWIRE®
with Optical Absolute Encoder
Profibus DP



Interface HPROF Absolute encoder Profibus 	Excitation voltage	10 ... 30 V DC
	Excitation current	250 mA
	Interface	RS485
	Protocol	Profibus DP with encoder profile C2
	Resolution	12 (10 ... 14) + 12 bit
	Output code	Binary
	Baud rate	Automatically selected between 9,6 kBaud and 12 MBaud
	Programmability	Resolution, preset, direction
	Integrated special functions	Velocity, acceleration, operating time
	Bus terminating resistor	Selectable via DIP switch
	Connection	Bus cover with T manifold
	EMC	EN 61326-1:2013

Signal wiring	Signal	Cable terminal no. (bus cover)
	U _B in	1
	0V in	2
	U _B out	3
	0V out	4
	B in	5
	A in	6
	B out	7
	A out	8

Notes: Download of the manual and the configuration file of the encoder at the ASM website www.asm-sensor.com in the "Downloads" section (hprof_de_en.zip).

The encoder parameters must be set before operation!

In the subsequent electronics the 12 bit LSB resolution of the data sheet must be considered as a scaling factor.

If the encoder is set to another single turn resolution, the scaling factor is the result of the resolution of the cable drum of the WS sensor per revolution and the resolution of the encoder.

Example:

WS19KT-15000 with angle encoder 13 bit/revolution, distance/revolution 600 mm

Scaling factor: $600 \text{ mm} / 2^{13} = 600 \text{ mm} / 8192 = 0,073242 \text{ mm} / \text{Bit}$ (= LSB resolution)

POSIWIRE®
with Optical Absolute Encoder
Interbus



Interface HINT Absolute encoder Interbus 	Excitation voltage	10 ... 30 V DC
	Excitation current	250 mA
	Interface	Interbus, ENCOM profile K3 (configurable), K2
	Output code	32 Bit binary
	Baud rate	500 kBaud
	Data refresh	Every 600 µs
	Resolution	12 (10 ... 14) + 12 bit
	Programmability	Direction, preset, offset, resolution
	Connection	Bus cover with T manifold
	EMC	EN 61326-1:2013

Data format Interbus K2/K3		Differential signals (RS485) ENCOM profile K3, K2, 32 Bit, binary process data				
	DT-Format	Supi address	0	1	2	3
	(according to the Phoenix company)	Byte No.	3	2	1	0
	ID code K2	36 H (= 54 dec.)				
	ID code K3	37 H (= 55 dec.)				

Signal wiring	Signal	Cable terminal no. (bus cover)
	U _B +	1
	GND	2
	DI1	3
	$\overline{DI1}$	4
	DO1	5
	$\overline{DO1}$	6
	DO2	7
	$\overline{DO2}$	8
	DI2	9
	$\overline{DI2}$	10
	RBST	11
	GND	12

Voltage divider
R1K
 Potentiometer

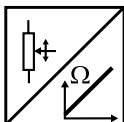

The metal wiper of the potentiometer must be protected against current load! Electrical current flow impact on the wiper causes linearity errors and shortens the lifetime of the potentiometer.

The output signal is the ratiometric voltage of a potentiometer. The potentiometer is supplied by a reference voltage source. The ratio of the output signal to the reference voltage is proportional to the measuring cable extension. For optimum performance of the sensor 94% (3% to 97%) of the potentiometers total span is used for the specified measurement range. Provision for setting the electrical zero and voltage amplification must be made in the subsequent signal processing circuit.

Suggested output circuit

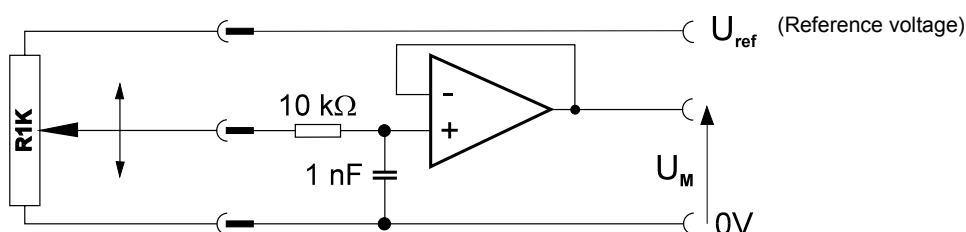

Voltage output
0 ... 10 V (10V)

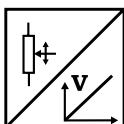

This output signal is 0 to 10 Volts proportional to the measuring cable extension of 0 to 100%. This is an industry standard output which is widely accepted because of its simple signal processing and suitability for all display, recording and automation systems. For analog signal processing the voltage output is the proven best choice, e.g. for Waveform Analyzers, Data Loggers and for analog and digital Oscilloscopes. ASM's 0...10 V output supports a wide range of excitation voltages and is well protected against electromagnetic interference.

Suggested output circuit

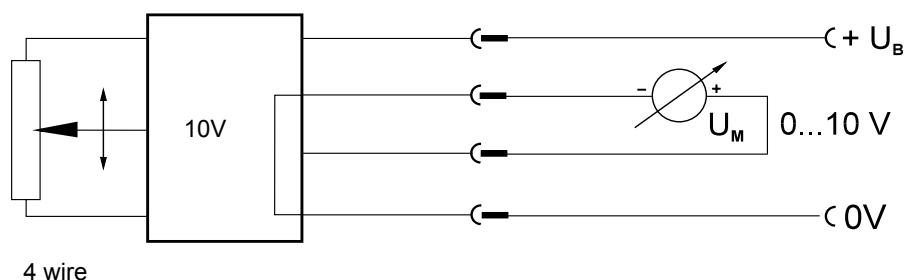
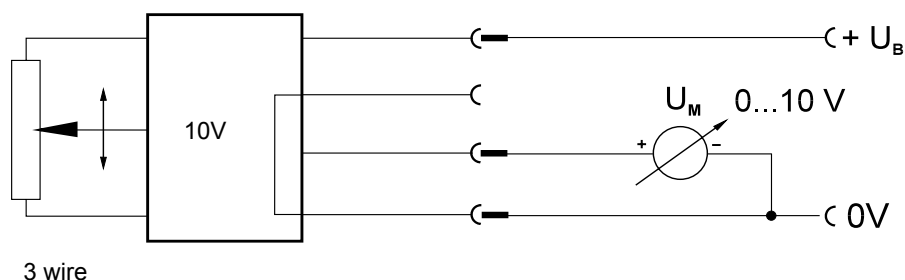

Current output
4 ... 20 mA (420A)
 (2 wire)

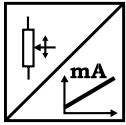

This output signal is a 4 to 20 mA current loop proportional to the measuring cable extension of 0 to 100%. It is an industry standard two-wire system for the transmission of measured values. The current loop is both measurement signal and sensor excitation current. The measured value is represented as a voltage drop across a load resistor R_M . The current is constant and the signal cable resistance (R_L) will have no effect on the measured value. Therefore long signal cables can be used, limited only by the cable resistance (impedance). Signal cable disconnection or failure can be detected by a 0 mA current signal.

Suggested output circuit

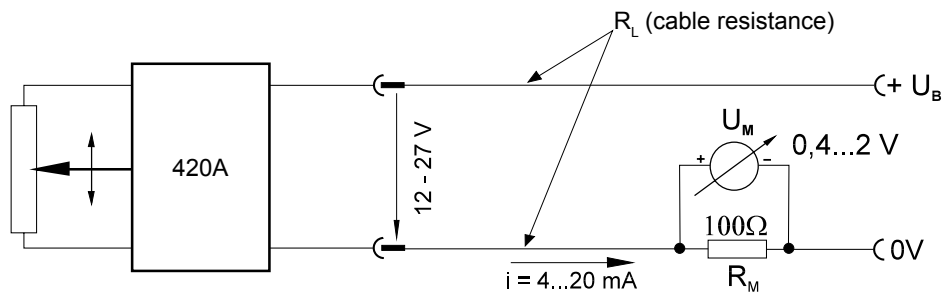

Current output
4 ... 20 mA (420T)
 (3 wire)

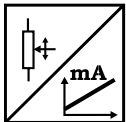

This output signal is a 4 to 20 mA current loop (alternatively 0 to 20 mA) proportional to the measuring cable extension of 0 to 100%. The 3 wire current loop system is especially resistant to electromagnetic interference because of the separate sensor excitation and the low resistance (impedance) of the signal processing electronics. As in the two-wire system the measured value is represented as a voltage drop across a load resistor R_M and is, within limits, independent of the cable resistance (impedance).

Suggested output circuit

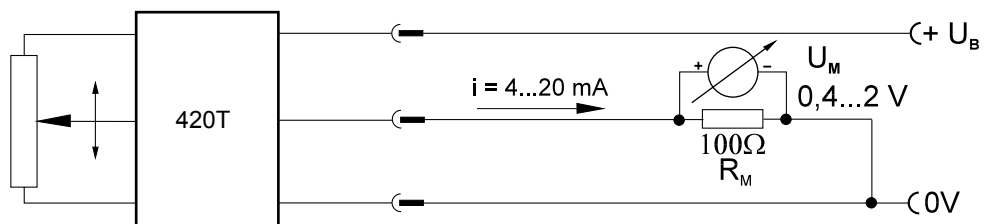

Programming of the start and end value by the customer

Option -PMUI, -PMUV

Two-wire programming

Teach-In of start and end value for the options PMUI and PMUV is provided by two binary signals ZERO and END. At the start position connect signal ZERO for a short period to GND via push button. At the end position connect signal END for a short period to GND. The taught positions will be stored non-volatile. To reset the sensor to factory default both signals ZERO and END must be connected to ground while powering up the sensor.

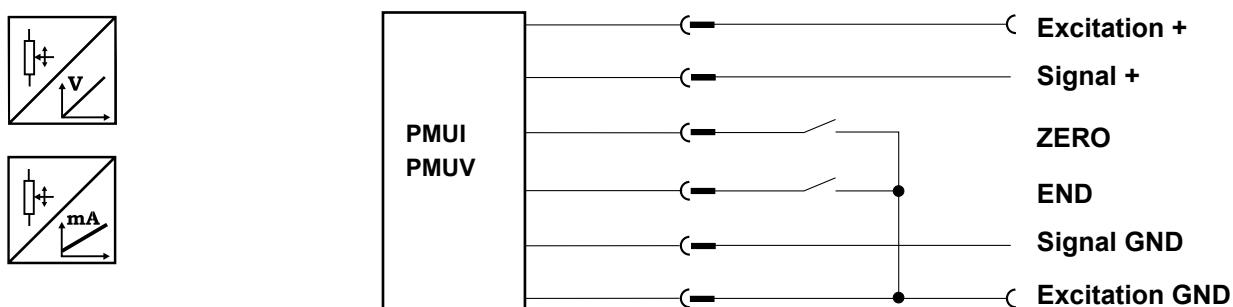

Option -U2/PMU, -I1/PMU, -U8/PMU

Single-wire programming

Teach-In of start and end value for the options U2/PMU, I1/PMU, U8/PMU is provided by a binary signal ZERO/END. At the start position connect signal ZERO/END for a period of 2 ... 3 seconds to GND via push button. At the end position connect signal ZERO/END for a period of 5 ... 6 seconds to GND via a push button. The taught positions will be stored non-volatile. To reset the sensor to factory default signal ZERO/END must be connected to ground while powering up the sensor for 2 ... 3 seconds.

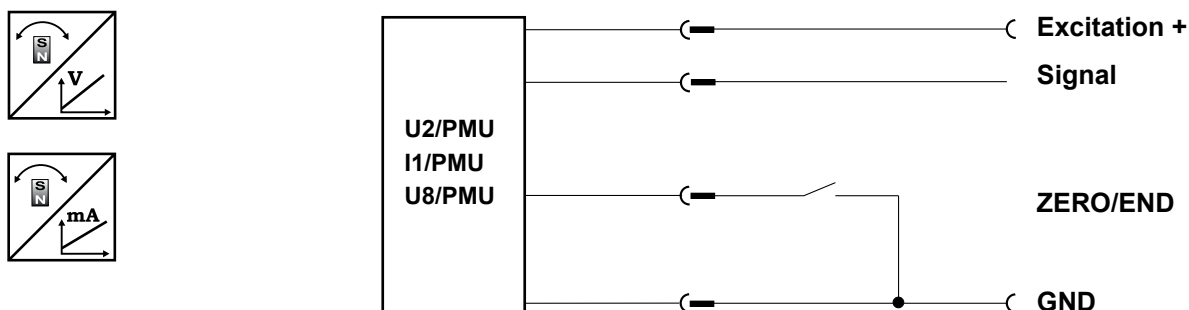

SSI Interface

The data is transmitted with the use of both the CLOCK and DATA signals. The system controller (PLC, microcomputer) sends the CLOCK signal which also determines the data transmission rate. With the first falling edge of the CLOCK signal, the position data is captured. The next rising edges control the A/D conversion, encoding and release of data word. After a time delay, the next new position data will be transmitted.



Warning Note:

If the GND (0V) signal connection is missing the signals DATA and $\overline{\text{DATA}}$ will rise to the potential of the excitation voltage. This may damage the input circuit of the subsequent processing unit if this unit is not connected with galvanic isolation (e.g. opto-coupling devices). This will happen especially when the mating connector is disconnected while power is on.

Wiring

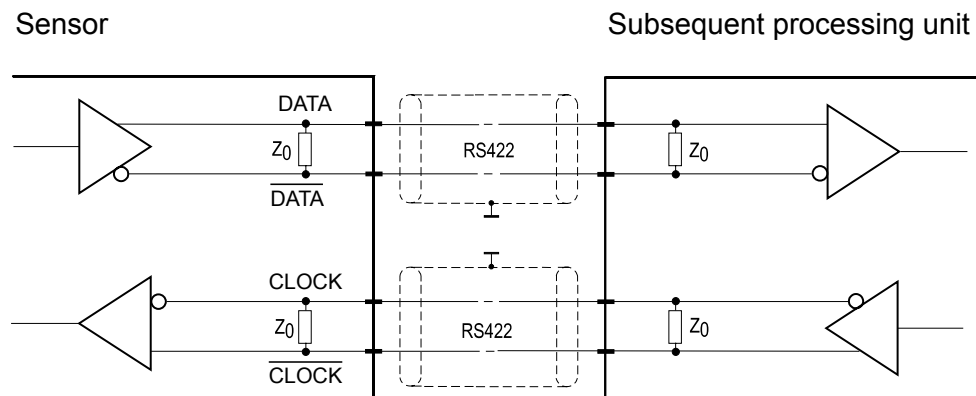

Models	WS10Px, WS12P, WS17P	
Outputs	single-channel (magnetic encoder)	
	U2	Voltage output 0,5 ... 10 V
	U8	Voltage output 0,5 ... 4,5 V
	I1	Current output 4 ... 20 mA
	MCANOP	CAN-BUS (CANopen)
	MCANJ1939	CAN-BUS (SAE J1939)
	MSSI	SSI output
	dual-channel (magnetic encoder)	
	U2R	Voltage output 0,5 ... 10 V, redundant
	U8R	Voltage output 0,5 ... 4,5 V, redundant
	I1R	Current output 4 ... 20 mA, redundant
	MCANOPR	CAN-BUS, redundant (CANopen)
	MCANJ1939	CAN-BUS, redundant (SAE J1939)
	Characteristics	Device type
Life period (electronics) $MTTF_d$		320 years / channel ^{*)}
Probability of failure PFH (λ_{DU})		350 Fit / channel
Life period (mechanics) B_{10}		$5 \cdot 10^6$ cycles (draft)
Probability of failure (mechanics) λ_{MECH}		$0,1 \cdot C_h / B_{10}$ C_h = cycles per hour
Working life		10 years
Calibration intervall		annually
Operating conditions	Pull-out speed (max)	1 m/s
	Pull-in speed (max)	1 m/s
	Assembly	No deflection
Standards	Functional Safety	IEC 61508-1, -2, -6
	Safety of machinery	ISO 13849-1
	Failure rate of electronic components (Siemens)	SN 29500

*) = Reference conditions: Reference Supply $U_{REF} = 24$ V, Reference Temperature $\vartheta_{REF} = 60$ °C

Declaration of Conformity

We **ASM GmbH**
Am Bleichbach 18 - 24
D-85452 Moosinning



declare under our sole responsibility that the product

Name: Position sensor

Type: **WS7.5, WS10, WS10P, WS12, WS12P, WS17, WS17P, WS19,
WS31, WS42, WS58, WS60, WS61, WS100M**

to which this declaration relates is in conformity with the following standards or other normative documents:

Directives: 2004/108/EG (EMV)

Standards: EN 61326-1:2013 (EMV)

Moosinning, 02.09.2013



p.p. Peter Wirth
Head of Development



A large area of the page is filled with horizontal dotted lines, providing a template for handwritten notes or data entry.



A large area of the page is filled with horizontal dotted lines, providing a template for handwritten notes or data entry.

ASM GmbH Automation • Sensorik • Messtechnik

Am Bleichbach 18-24

85452 Moosinning / Germany

Telephone: +49 8123 986-0

Telefax: +49 8123 986-500

Internet: www.asm-sensor.com

E-Mail: info@asm-sensor.de

