

PR
electronics



5202

Pulse isolator

No. 5202V108-UK

From ser. no. 030481661



- DK** ▶ PR electronics A/S tilbyder et bredt program af analoge og digitale signalbehandlingsmoduler til industriel automation. Programmet består af Isolatorer, Displays, Ex-barrierer, Temperaturtransmittere, Universaltransmittere mfl. Vi har modulerne, du kan stole på i selv barske miljøer med elektrisk støj, vibrationer og temperaturudsving, og alle produkter opfylder de strengeste internationale standarder. Vores motto »Signals the Best« er indbegrebet af denne filosofi - og din garanti for kvalitet.
- UK** ▶ PR electronics A/S offers a wide range of analogue and digital signal conditioning devices for industrial automation. The product range includes Isolators, Displays, Ex Interfaces, Temperature Transmitters, and Universal Devices. You can trust our products in the most extreme environments with electrical noise, vibrations and temperature fluctuations, and all products comply with the most exacting international standards. »Signals the Best« is the epitome of our philosophy - and your guarantee for quality.
- FR** ▶ PR electronics A/S offre une large gamme de produits pour le traitement des signaux analogiques et numériques dans tous les domaines industriels. La gamme de produits s'étend des transmetteurs de température aux afficheurs, des isolateurs aux interfaces SI, jusqu'aux modules universels. Vous pouvez compter sur nos produits même dans les conditions d'utilisation sévères, p.ex. bruit électrique, vibrations et fluctuations de température. Tous nos produits sont conformes aux normes internationales les plus strictes. Notre devise »SIGNALS the BEST« c'est notre ligne de conduite - et pour vous l'assurance de la meilleure qualité.
- DE** ▶ PR electronics A/S verfügt über ein breites Produktprogramm an analogen und digitalen Signalverarbeitungsmodulen für die industrielle Automatisierung. Dieses Programm umfasst Displays, Temperaturtransmitter, Ex- und galvanische Signaltrenner, und Universalgeräte. Sie können unsere Geräte auch unter extremen Einsatzbedingungen wie elektrisches Rauschen, Erschütterungen und Temperaturschwingungen vertrauen, und alle Produkte von PR electronics werden in Übereinstimmung mit den strengsten internationalen Normen produziert. »Signals the Best« ist Ihre Garantie für Qualität!

PULSE ISOLATOR

5202

Contents

Warning.....	2
Symbol identification	3
Safety instructions.....	3
How to dismantle system 5000.....	5
Application.....	6
Technical characteristics.....	6
Mounting / installation.....	6
Applications.....	7
Order: 5202.....	8
Electrical specifications.....	8
Jumper programming	10
Function description.....	11
Block diagram: 5202A1 and 5202A2	12
Block diagram: 5202A4.....	13
Block diagram: 5202B1 and 5202B2.....	14
Block diagram: 5202B4.....	15
Connections	16
UL Control Drawing 5202QU01.....	17



GENERAL

WARNING

This module is designed for connection to hazardous electric voltages. Ignoring this warning can result in severe personal injury or mechanical damage.

To avoid the risk of electric shock and fire, the safety instructions of this manual must be observed and the guidelines followed.

The specifications must not be exceeded, and the module must only be applied as described in the following.

Prior to the commissioning of the module, this manual must be examined carefully.

Only qualified personnel (technicians) should install this module. If the equipment is used in a manner not specified by the manufacturer, the protection provided by the equipment may be impaired.



**HAZARD-
OUS
VOLTAGE**

WARNING

Until the module is fixed, do not connect hazardous voltages to the module. The following operations should only be carried out on a disconnected module and under ESD-safe conditions:

Dismantlement of the module for setting of dipswitches and jumpers.

General mounting, connection and disconnection of wires.

Troubleshooting the module.



Repair of the module and replacement of circuit breakers must be done by PR electronics A/S only.



**INSTAL-
LATION**

WARNING

5202B4:

To keep the safety distances, one relay must not be connected to hazardous voltage at the same time as the other relay on the same channel is connected to non-hazardous voltage.

SYMBOL IDENTIFICATION



Triangle with an exclamation mark: Warning / demand. Potentially lethal situations.



The CE mark proves the compliance of the module with the essential requirements of the directives.



The double insulation symbol shows that the module is protected by double or reinforced insulation.



Ex modules have been approved acc. to the ATEX directive for use in connection with installations in explosive areas.

SAFETY INSTRUCTIONS

DEFINITIONS

Hazardous voltages have been defined as the ranges: 75...1500 Volt DC, and 50...1000 Volt AC.

Technicians are qualified persons educated or trained to mount, operate, and also troubleshoot technically correct and in accordance with safety regulations.

Operators, being familiar with the contents of this manual, adjust and operate the knobs or potentiometers during normal operation.

RECEIPT AND UNPACKING

Unpack the module without damaging it and make sure that the manual always follows the module and is always available. The packing should always follow the module until this has been permanently mounted.

Check at the receipt of the module whether the type corresponds to the one ordered.

ENVIRONMENT

Avoid direct sunlight, dust, high temperatures, mechanical vibrations and shock, as well as rain and heavy moisture. If necessary, heating in excess of the stated limits for ambient temperatures should be avoided by way of ventilation.

All modules fall under Installation Category II, Pollution Degree 1, and Insulation Class II.

MOUNTING

Only technicians who are familiar with the technical terms, warnings, and instructions in the manual and who are able to follow these should connect the module.

Should there be any doubt as to the correct handling of the module, please contact your local distributor or, alternatively,

PR electronics A/S,
www.prelectronics.com

Mounting and connection of the module should comply with national legislation for mounting of electric materials, i.e. wire cross section, protective fuse, and location. Descriptions of input / output and supply connections are shown in the block diagram and on the side label.

The following apply to fixed hazardous voltages-connected modules:

The max. size of the protective fuse is 10 A and, together with a power switch, it should be easily accessible and close to the module. The power switch should be marked with a label indicating that it will switch off the voltage to the module.

Year of manufacture can be taken from the first two digits in the serial number.

CALIBRATION AND ADJUSTMENT

During calibration and adjustment, the measuring and connection of external voltages must be carried out according to the specifications of this manual. The technician must use tools and instruments that are safe to use.

NORMAL OPERATION

Operators are only allowed to adjust and operate modules that are safely fixed in panels, etc., thus avoiding the danger of personal injury and damage. This means there is no electrical shock hazard, and the module is easily accessible.

CLEANING

When disconnected, the module may be cleaned with a cloth moistened with distilled water.

LIABILITY

To the extent the instructions in this manual are not strictly observed, the customer cannot advance a demand against PR electronics A/S that would otherwise exist according to the concluded sales agreement.

HOW TO DISMANTLE SYSTEM 5000

First, remember to demount the connectors with hazardous voltages.



Picture 1:

By lifting the bottom lock, the module is detached from the DIN rail.

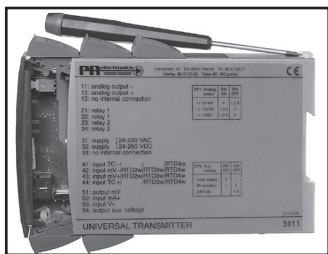

Picture 2:

Then, by lifting the upper lock and pulling the front plate simultaneously, the PCB is removed. Switches and jumpers can now be adjusted.

PULSE ISOLATOR

5202

- *2 channels - 2 or 4 outputs*
- *5-port 3.75 kVAC galvanic isolation*
- *Dual output*
- *Cable error detection*
- *Universal AC or DC supply*

Application

- Pulse isolator for the supply of NAMUR sensors. 5202B1, -B2 and -B4 have a safety barrier for the supply of NAMUR sensors installed in hazardous area.
- Pulse isolator for the detection of mechanical contacts. 5202B1, -B2 and -B4 have a safety barrier for the detection of mechanical contacts installed in hazardous area.
- One input signal can be used on two separate outputs.
- A cable error alarm can be detected on a separate output.

Technical characteristics

- PR5202A1, -A2, -B1 and -B2 have relays with change-over contacts or open NPN collectors. For 5202B1 and -B2 these are available in the safe area.
- PR5202A4 and -B4 have 4 SPST relays, which are activated simultaneously two and two. Each relay can be programmed to the function N.O. or N.C. For 5202B4 the relays are available in the safe area.
- Inputs, outputs, and supply are floating and galvanically separated.
- The 5202 is designed according to strict safety requirements and is thus suitable for application in SIL 2 installations.

Mounting / installation

- Mounted vertically or horizontally on a DIN rail. Up to 84 channels per metre can be mounted.

APPLICATIONS

NAMUR sensors

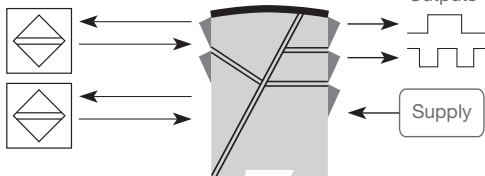

1 NAMUR sensor

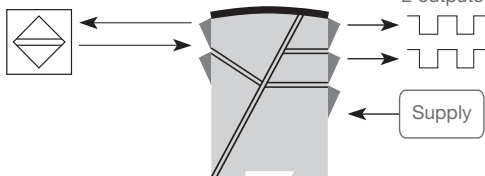

Contact with cable error detection

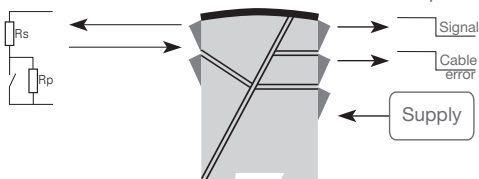

Contact

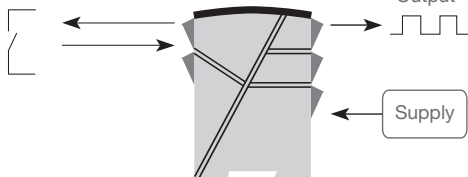

Order: 5202

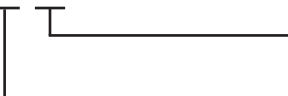

Type	Version	Output
5202	Standard : A	Open collector NPN : 1 2x1 relay : 2
	ATEX Ex : B	2x2 relays : 4

Electrical specifications

Specifications range:

-20 to +60°C

Common specifications:

Supply voltage universal 21.6...253 VAC
50...60 Hz
19.2...300 VDC

Internal consumption,
5202A1, -A2, -B1 and -B2 ≤ 1.5 W (2 channels)

Max. consumption,
5202A1, -A2, -B1 and -B2 ≤ 1.5 W (2 channels)

Internal consumption, 5202A4 and -B4 ≤ 2.0 W (2 channels)

Max. consumption, 5202A4 and -B4 ≤ 2.0 W (2 channels)

Fuse 400 mA T / 250 VAC

Isolation voltage, test / operation 3.75 kVAC / 250 VAC

Calibration temperature 20...28°C

EMC immunity influence < ±0.5%

Extended EMC immunity:

NAMUR NE 21, A criterion, burst < ±1%

Auxiliary voltage:

NAMUR supply 8 VDC / 8 mA

Max. wire size 1 x 2.5 mm² stranded wire

Screw terminal torsion 0.5 Nm

Relative humidity < 95% RH (non-cond.)

Dimensions (HxWxD) 109 x 23.5 x 130 mm

DIN rail type DIN 46277

Protection degree IP20

Weight 230 g

Inputs:

Sensor types:

NAMUR acc. to.....	EN 60947-5-6
Mechanical contact	
Frequency range	0...5 kHz
Pulse length.....	> 0.1 ms
Input resistance.....	1 k Ω
Trig level, signal	< 1.2 mA, > 2.1 mA
Trig level, cable error.....	< 0.1 mA, > 6.5 mA

Outputs:**Relay outputs:**

Max. frequency	20 Hz
Max. voltage	250 VRMS
Max. current.....	2 A / AC
Max. AC power	100 VA
Max. load at 24 VDC.....	1 A

Open NPN collector outputs:

Max. frequency	5 kHz
Pulse length.....	> 0.1 ms
Load, max. current / voltage	80 mA / 30 VDC
Voltage drop at 25 mA / 80 mA	< 0.75 VDC / < 2.5 VDC









Approvals:





EMC 2004/108/EC	EN 61326-1
LVD 2006/95/EC.....	EN 61010-1
PELV/SELV	IEC 364-4-41 and EN 60742
UL.....	UL 508
EAC TR-CU 020/2011.....	EN 61326-1









Ex / I.S. - 5202B:

ATEX 94/9/EC.....	DEMKO 99ATEX127186
UL.....	UL 913
EAC Ex TR-CU 012/2011	RU C-DK.GB08.V.00410

JUMPER PROGRAMMING

Signal transmission	Channel 1 JP 11	Channel 2 JP 21	Cable error detection	Channel 1 JP 12	Channel 2 JP 22
Direct	 1 2 3	 1 2 3	ON	 1 2 3	 1 2 3
Inverted	 1 2 3	 1 2 3	OFF	 1 2 3	 1 2 3

Channel 1 signal to channel 2	Channel 1 JP 13	Channel 2 function	Channel 2 JP 23
Cable error	 1 2 3	Channel 1 to channel 2 ON, input 2 disabled	 1 2 3
Signal	 1 2 3	Channel 1 to channel 2 OFF, input 2 active	 1 2 3

5202B4			
Relay function		N.O.	N.C.
Channel 1	Relay 1, JP41	 N.O. N.C.	 N.O. N.C.
	Relay 2, JP42	 N.O. N.C.	 N.O. N.C.
Channel 2	Relay 1, JP51	 N.O. N.C.	 N.O. N.C.
	Relay 2, JP52	 N.O. N.C.	 N.O. N.C.

- When a channel 1 signal or cable errors are transmitted to channel 2, JP 22 must be in position 2-3, and JP 23 must be in position 1-2.
- Signal transmission to channel 2: If the channel 1 signal is inverted (JP11 in position 2-3), the channel 2 signal will also be inverted. In this case, the inversion on channel 2 can be reversed by inverting the channel 2 signal (JP21 in position 2-3).
- When channel 2 is used individually, input 2 is activated by JP 23 in position 2-3.

FUNCTION DESCRIPTION

Examples of connections on block diagram (1)...(4)

- (1) NAMUR sensor with cable error detection in case of cable disconnection or short-circuit.
- (2) Mechanical contact with cable error detection in case of cable disconnection or short-circuit, when R_s and R_p are mounted on the contact.
- (3) Mechanical contact with cable error detection in case of cable disconnection, when R_p is mounted on the contact.
- (4) Mechanical contact without cable error detection.

BLOCK DIAGRAM: 5202A1 AND 5202A2

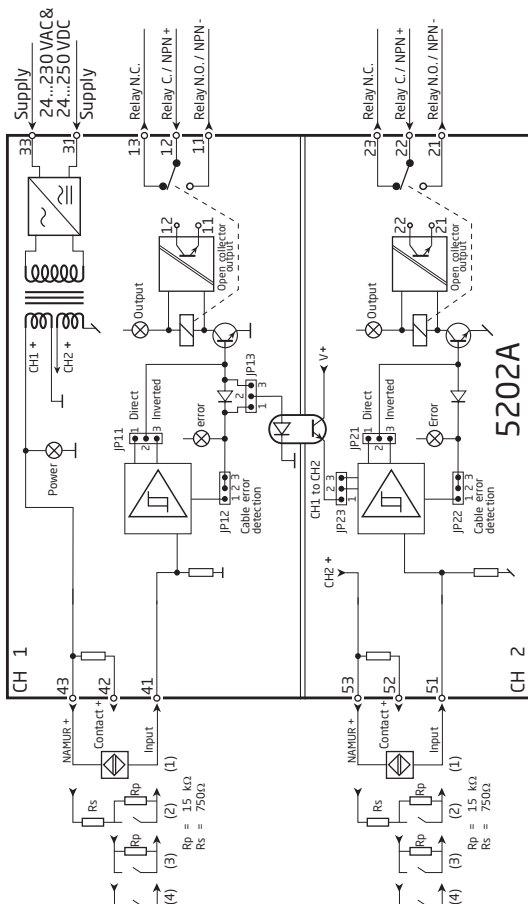

BLOCK DIAGRAM: 5202A4

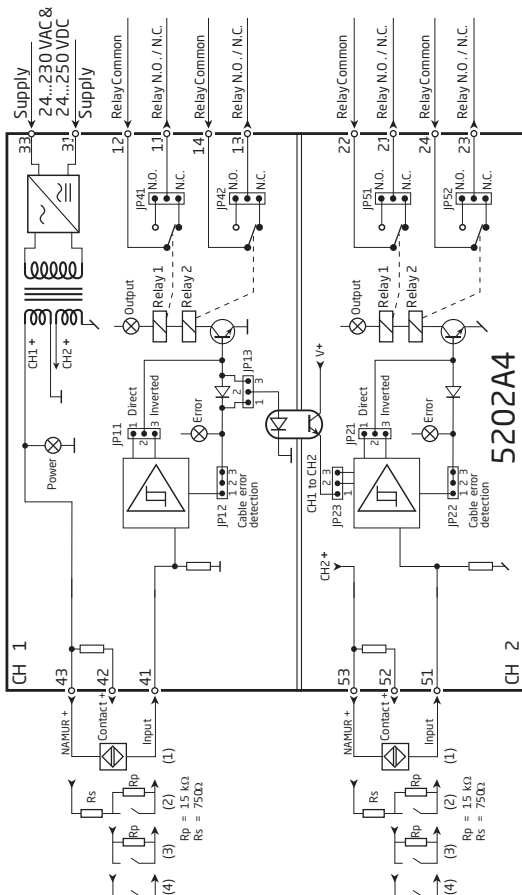

BLOCK DIAGRAM: 5202B1 AND 5202B2

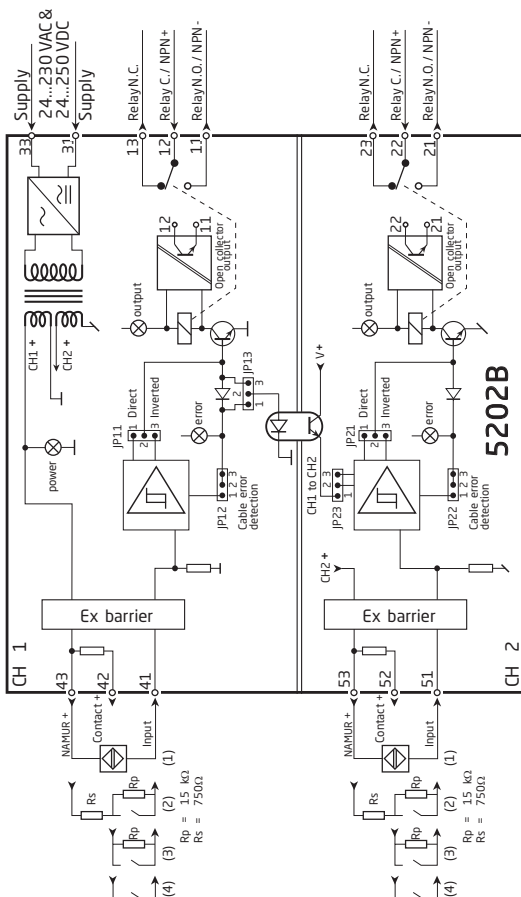

BLOCK DIAGRAM: 5202B4

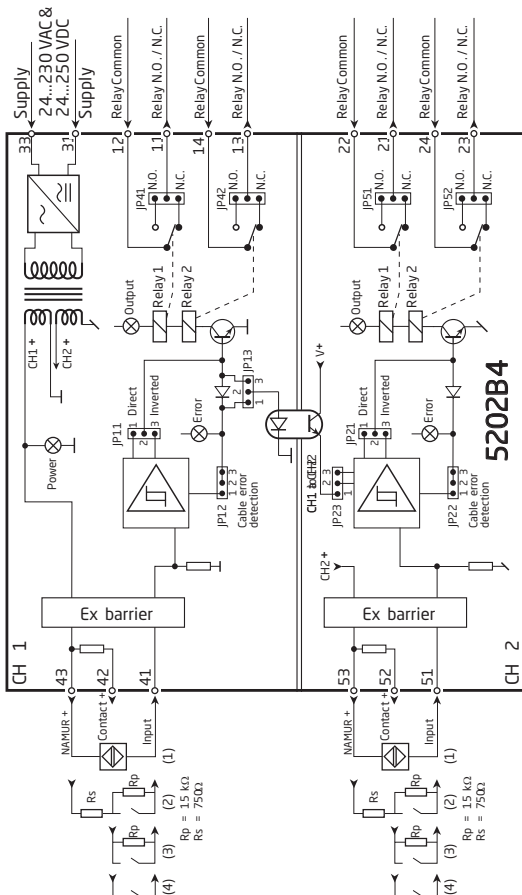

CONNECTIONS

Supply:

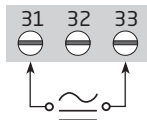

Inputs:

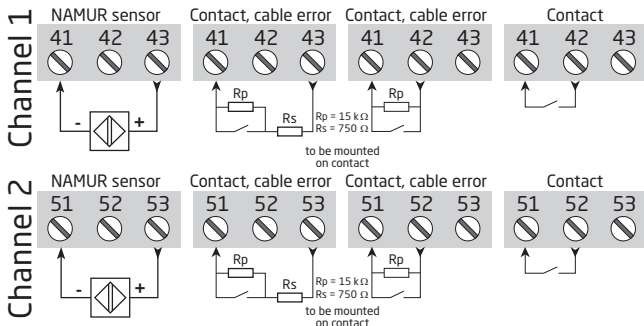

Outputs:

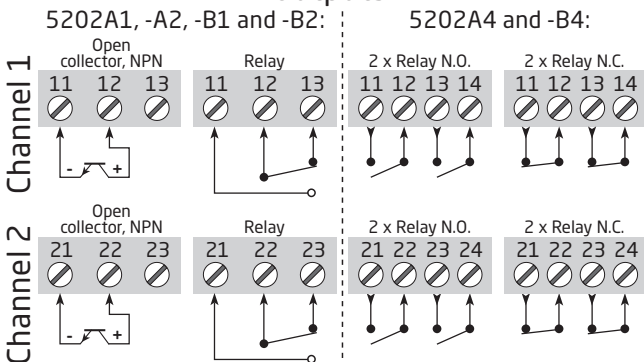

UL CONTROL DRAWING 5202QU01

Hazardous (Classified) Location

Class I, Division 1, Group A,B,C,D
 Class I, Zone 0 and 1, Group IIC
 Class II, Division 1 Group E, F, G

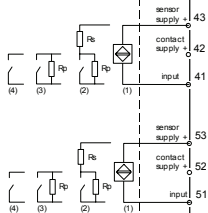

Nonhazardous

Associated apparatus
 Galvanic Isolated

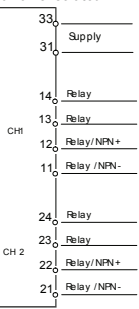

Intrinsically safe apparatus
 entity parameters:

$$V_{max}(U_i) \geq V_t(U_o)$$

$$I_{max}(I_i) \geq I_t(I_o)$$

$$P_i \geq P_o$$

$$C_a \geq C_{cable} + C_i$$

$$L_a \geq L_{cable} + L_i$$

The sum of capacitance and inductance of cable and intrinsic safe equipment must be less or equal to C_a and L_a

5202B Associated apparatus parameters			
CH1	Terminals 41 to 43		
CH2	Terminals 51 to 53		
$V_t(U_o)$	10.6 V		
$I_t(I_o)$	13.8 mA		
P_o	0.038 W		
	IIC / grp. A,B	IIB / grp. C	IIA / grp.D
$C_a(C_o)$	1.9 μ F	4.0 μ F	50 μ F
$L_a(L_o)$	160 mH	600 mH	1 H
Relay output 11 - 14 , 21 - 24			
Voltage	250V AC, 100 VA		
Current	2 A AC, 100 VA		
24VDC	1 A DC		
Pilot Duty	120/240 V AC, 100V AC		
NPN output 11 - 12, 21 - 22			
General purpose	30V DC, 80 mA		
Pilot duty	30V DC, 80 mA		

Installation notes:

- 1) The maximum nonhazardous location voltage is 250Vac/dc.
- 2) The installation shall be in accordance with the National Electrical Code NFPA 70, Articles 504 and 505.
- 3) The terminals of the two individual channels shall not be interconnected in any way.
- 4) Install in Pollution degree 2 or better
- 5) Use 60 / 75 °C Copper Conductors with Wire Size AWG: (26 - 14).
- 6) Warning: Substitution of components may impair intrinsic safety.
- 7) If cable parameters are unknown C_{cable} may be set to 60pF/ft and L_{cable} may be set to 0.20 μ H/ft

Rev. AA 2003-09-19



Displays Programmable displays with a wide selection of inputs and outputs for display of temperature, volume and weight, etc. Feature linearization, scaling, and difference measurement functions for programming via PReset software.



Ex interfaces Interfaces for analog and digital signals as well as HART® signals between sensors / I/P converters / frequency signals and control systems in Ex zone 0, 1 & 2 and for some devices in zone 20, 21 & 22.



Isolation Galvanic isolators for analog and digital signals as well as HART® signals. A wide product range with both loop-powered and universal isolators featuring linearization, inversion, and scaling of output signals.



Temperature A wide selection of transmitters for DIN form B mounting and DIN rail devices with analog and digital bus communication ranging from application-specific to universal transmitters.



Universal PC or front programmable devices with universal options for input, output and supply. This range offers a number of advanced features such as process calibration, linearization and auto-diagnosis.





www.preelectronics.fr
sales-fr@preelectronics.com



www.preelectronics.de
sales-de@preelectronics.com



www.preelectronics.es
sales-es@preelectronics.com



www.preelectronics.it
sales-it@preelectronics.com



www.preelectronics.se
sales-se@preelectronics.com



www.preelectronics.com
sales-uk@preelectronics.com



www.preelectronics.com
sales-us@preelectronics.com



www.preelectronics.cn
sales-cn@preelectronics.com



www.preelectronics.be
sales-be@preelectronics.com

Head office

Denmark
PR electronics A/S
Lerbakken 10
DK-8410 Rønede

www.preelectronics.com
sales-dk@preelectronics.com
tel. +45 86 37 26 77
fax +45 86 37 30 85



QUALITY SYSTEM AND ENVIRONMENTAL
MANAGEMENT SYSTEM
DS/EN ISO 9001
DS/EN ISO 14001

